

Conceitos fundamentais desta aula:

Homologia vs. homoplasia

Fenética ou Taxonomia Numérica

Fenogramas

Inferência Filogenética:

- Obtenção de dados

- Codificação e evidências

- Avaliação e seleção de hipóteses

 - Grafos

 - OTUs e HTUs

 - Enumeração

 - Critério de otimização

 - Justificativa epistemológica

Problemas metodológicos da Fenética

O nascimento da Cladística

American Museum of Natural History – Década de 70.

Aristóteles – 384-322 A.C.

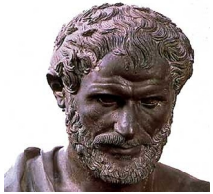

Darwin
1809-1882



1859

Período essencialista

Mundo dinâmico

Resistência e Nova Síntese

Sistemática Evolutiva

1936 - 1947

1960's

Fenética

1970's

Cladística

Carolus Linnaeus
1707-1778



Buffon
1707-1788



Lamarck
1744 -1829



St-Hilair
1772 -1844



Cuvier
1769 -1832



Ernest Mayr
1904 - 2005

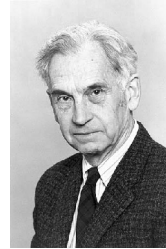

Paul Erlich

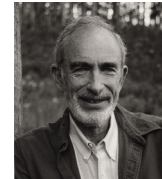

G.G. Simpson
1902 - 1984



Theodosius Dobzhansky
1900 -1975

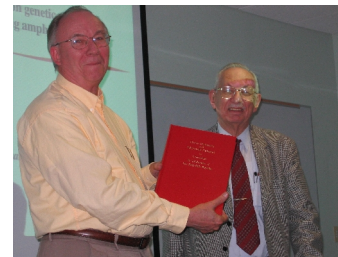

James Rohlf R. Sokal
1926 -

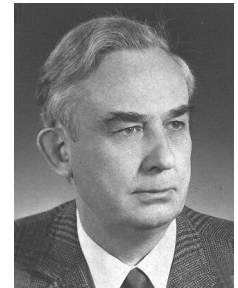

Willi Hennig
1913 - 1976



Steve Farris

Descendência com modificação:

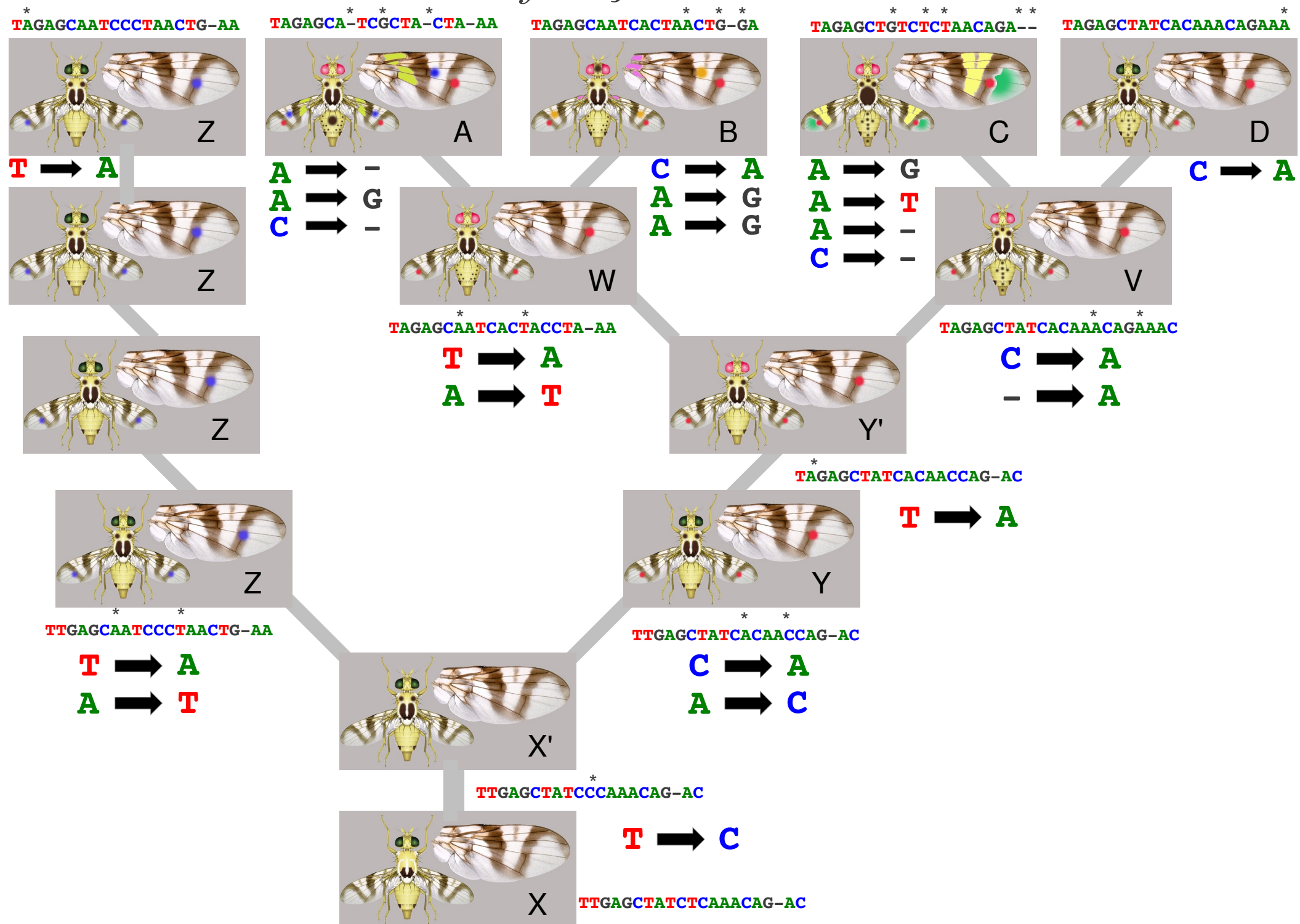

Lógica da inferência filogenética

“Operationally, systematics proceeds by gathering data (observations) from organisms and coding them into evidence to test competing phylogenetic scenarios”

(Wheeler et al., 2006:7)

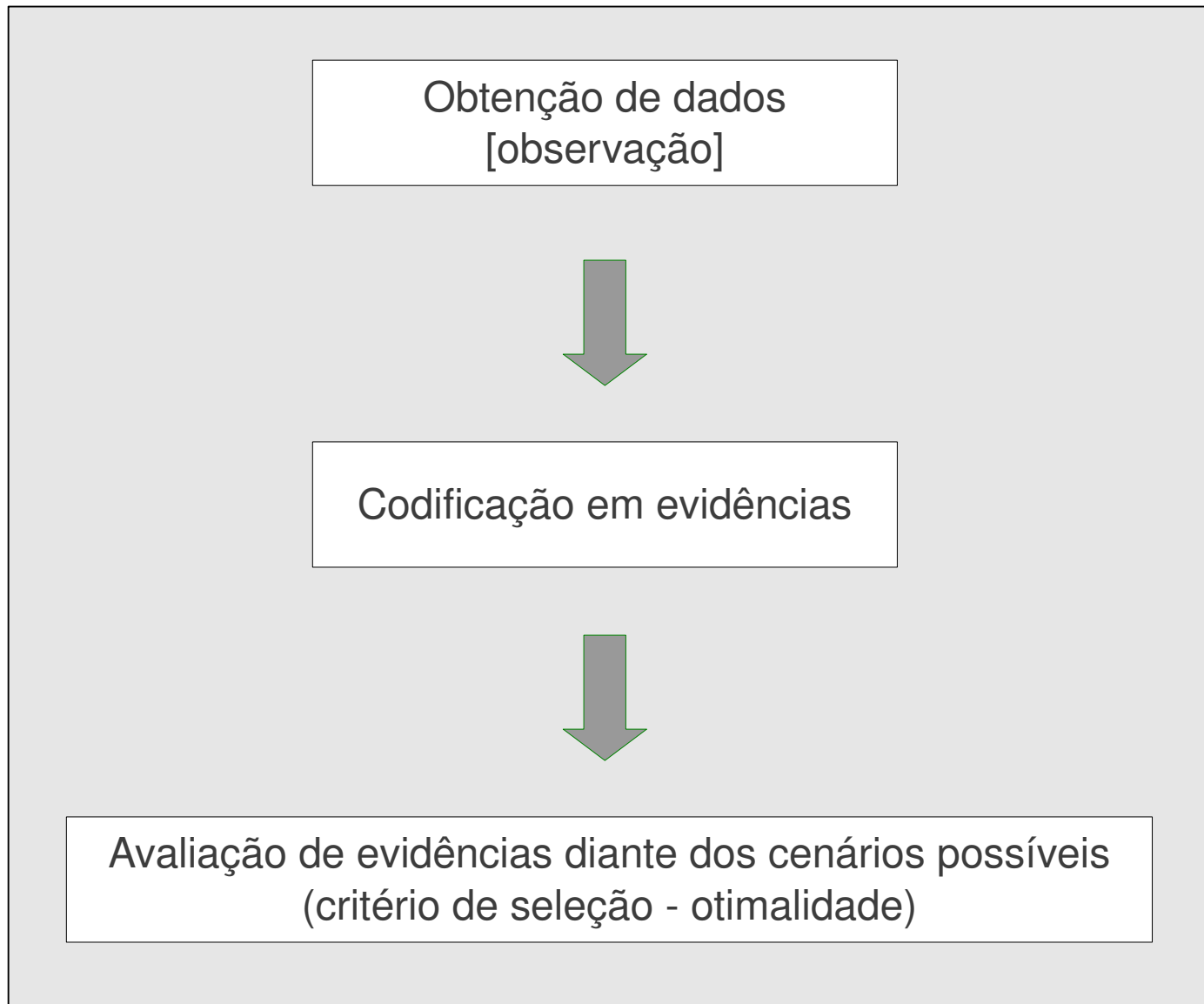

Lógica da inferência filogenética

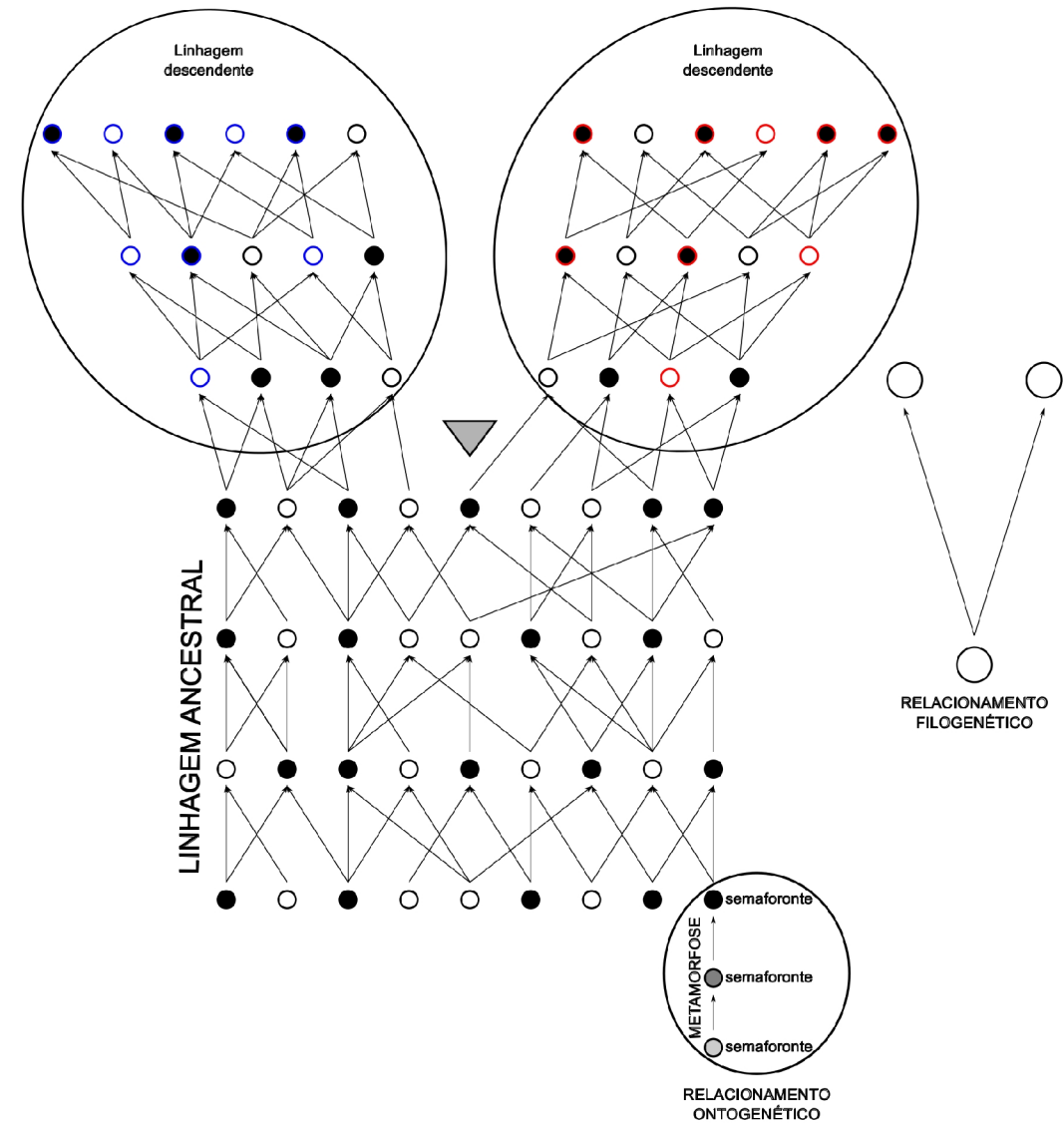
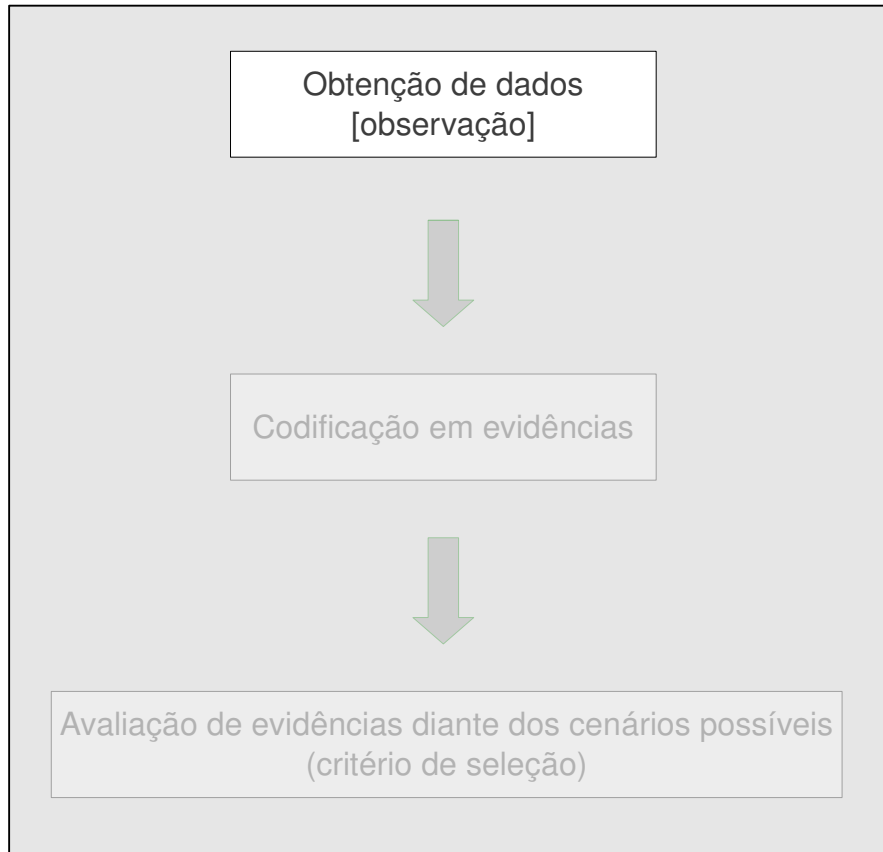

Lógica da inferência filogenética

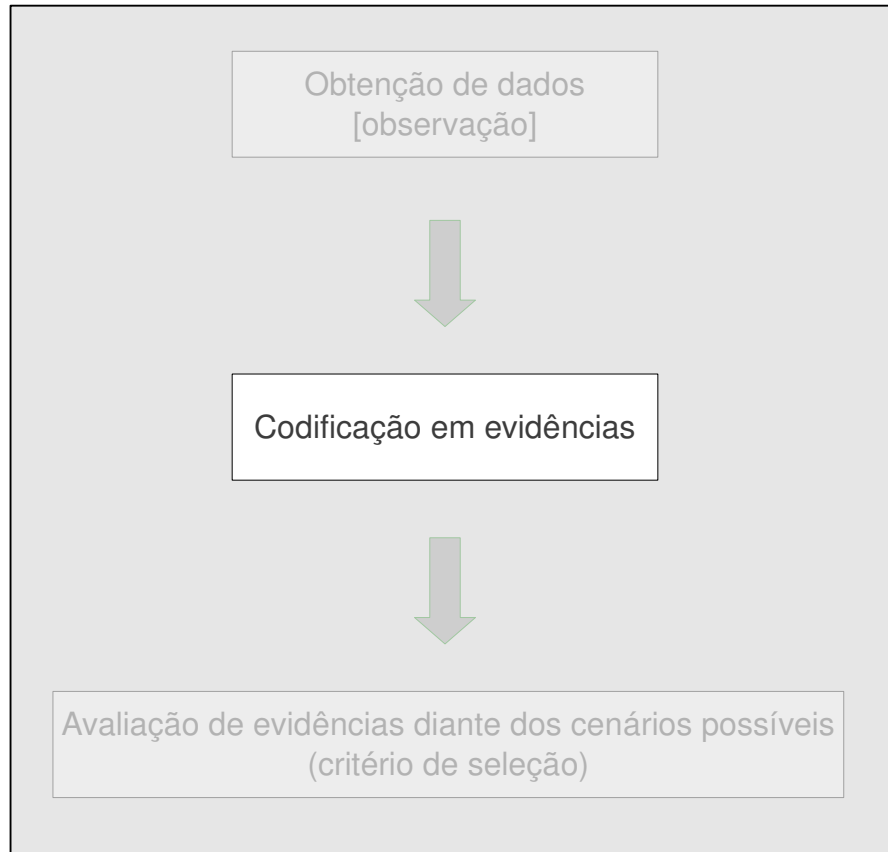

↓ ↓ ↓
 sp.X CTGGCTACGT
 sp.A TGGAGTAAGT
 sp.B CCTAGCAAGT
 sp.C CCTGATTGCA

Fenética:

EVIDÊNCIAS: similaridade global

sp.X CTGGCTACGT
 * ** **

sp.A TGGAGTAAGT

sp.X CTGGCTACGT
 * * **

sp.B CCTAGCAAGT

CODIFICAÇÃO: matriz de distância

	[X]	[A]	[B]	[C]
X	-			
A	5	-		
B	6	4	-	
C	7	9	7	-

Cladística:

EVIDÊNCIAS: transformação de estados de caracteres

1a. posição: C ↔ T

3a. posição: G ↔ T

10a. posição: T ↔ A

CODIFICAÇÃO: matriz de dados

	c ₁	c ₂	c ₃	c ₄	c ₅	c ₆	c ₇	c ₈	c ₉	c ₁₀
sp.X	1	3	2	2	1	3	0	1	2	3
sp.A	3	2	2	0	2	3	0	0	2	3
sp.B	1	1	3	0	2	1	0	0	2	3
sp.C	1	1	3	2	0	3	3	2	1	0

Lógica da inferência filogenética: Fenética

Problemas com o método:

1. Desconsidera que semelhanças decorrem de processos não relacionados com relação de parentesco.

2. Método é incapaz de manter as relações de distâncias originais para matrizes com mais de 4 terminais. Considere:

	[X]	[A]	[B]	[C]
X	-			
A	5	-		
B	6	4	-	
C	7	9	7	-

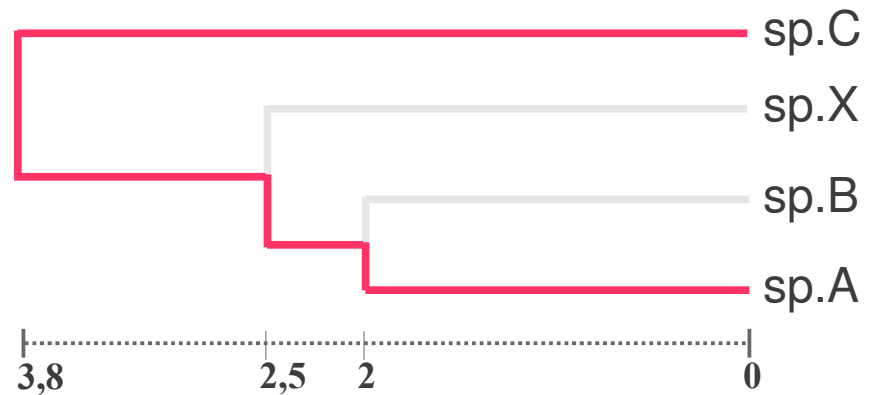

Lógica da inferência filogenética: Fenética

Problemas com o método:

3. Realismo:

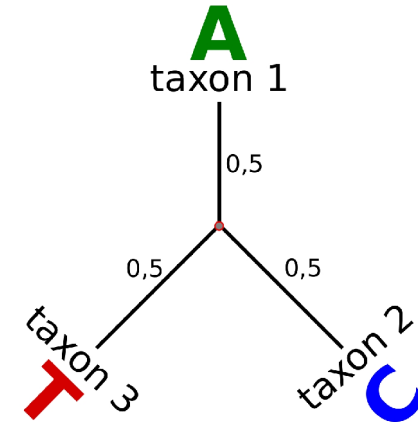
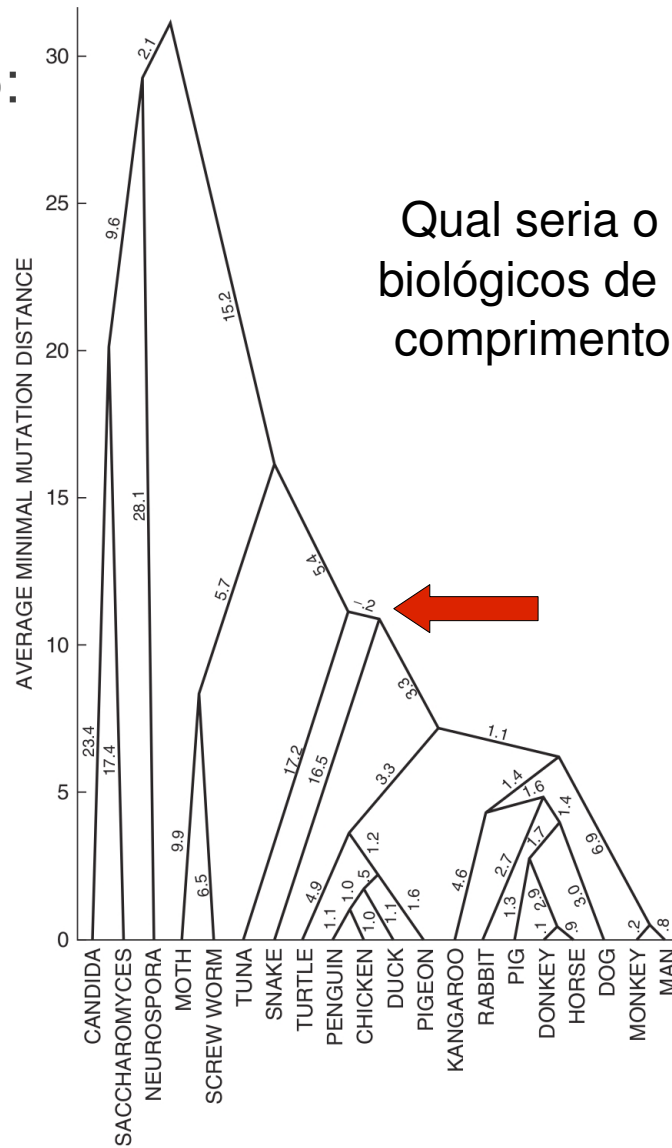

Qual seria o par de base presente no ancestral comum destes terminais?

Figure 9.13: Fitch–Margoliash analysis of cytochrome *c* protein sequences (Fitch and Margoliash, 1967). Note the negative branch length on the edge leading to tetrapods.

Lógica da inferência filogenética: Fenética

Problemas com o método:

4. Perda de informação:

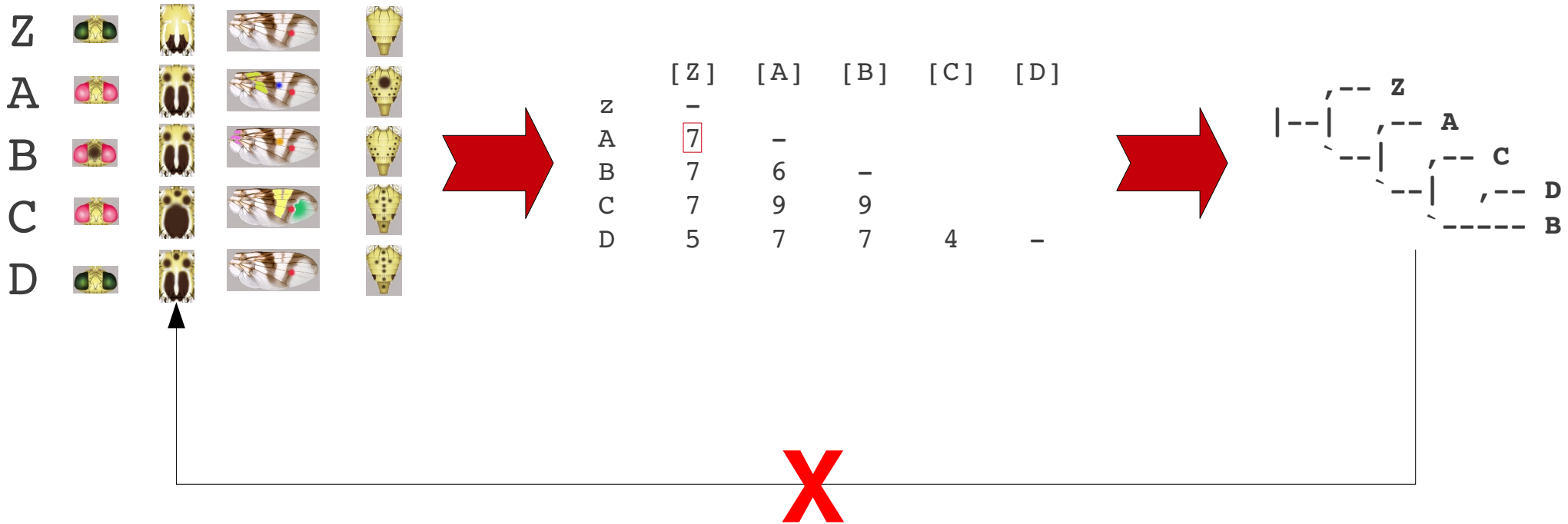

Lógica da inferência filogenética

Limitações da fenética:

1. Perda de informação
2. Dados heterogêneos tratados da mesma forma
3. Ausência de otimização de eventos de transformação de caracteres distintos

Limitações de um fenograma:

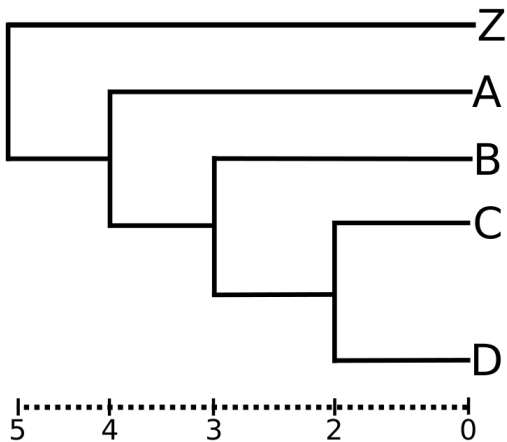

1. Não Permite reconstruções de ancestrais hipotéticos
2. Não permite proposições de homologia
3. Não permite identificar transformações de caracteres

↓ ↓ ↓
 sp.X CTGGCTACGT
 sp.A TGGAGTAAGT
 sp.B CCTAGCAAGT
 sp.C CCTGATTGCA

Fenética:

EVIDÊNCIAS: similaridade global

sp.X CTGGCTACGT
 * ** **
 sp.A TGGAGTAAGT

 sp.X CTGGCTACGT
 * * **
 sp.B CCTAGCAAGT

CODIFICAÇÃO: matriz de distância

	[X]	[A]	[B]	[C]
X	-			
A	5	-		
B	6	4	-	
C	7	9	7	-

“DISTANCE BASED”

Cladística:

EVIDÊNCIAS: transformação de estados de caracteres

- 1a. posição: C ↔ T
- 3a. posição: G ↔ T
- 10a. posição: T ↔ A

CODIFICAÇÃO: matriz de dados

	c ₁	c ₂	c ₃	c ₄	c ₅	c ₆	c ₇	c ₈	c ₉	c ₁₀
sp.X	1	3	2	2	1	3	0	1	2	3
sp.A	3	2	2	0	2	3	0	0	2	3
sp.B	1	1	3	0	2	1	0	0	2	3
sp.C	1	1	3	2	0	3	3	2	1	0

“CHARACTER BASED”

Codificação & Evidência de grupos

Fenética:

EVIDÊNCIAS: similaridade global

CRITÉRIO DE OTIMIZAÇÃO: Distância (fenética)

OBSERVAÇÃO: olhos apresentam duas cores:

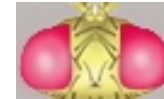

Este caráter sugere dois grupos:

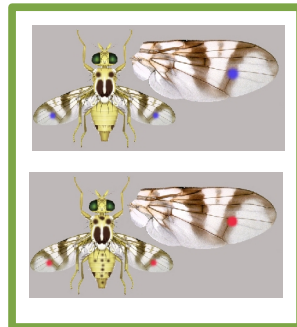

E

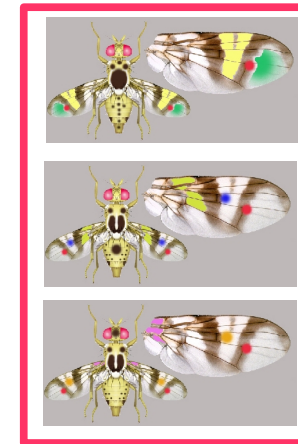

Codificação & Evidência de grupos

Cladística:

EVIDÊNCIAS: séries de transformações

CRITÉRIO DE OTIMIZAÇÃO: Número mínimo de transformações

OBSERVAÇÃO: olhos apresentam duas cores:

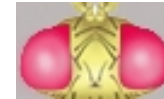

Este caráter sugere um desses grupos:

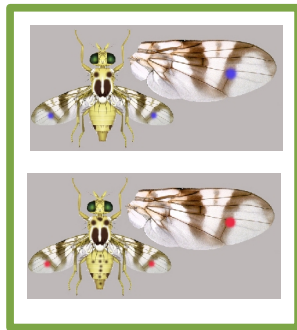
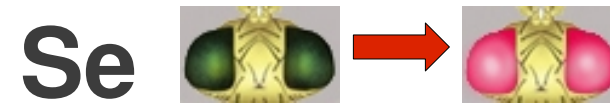
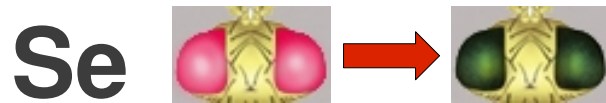

ou

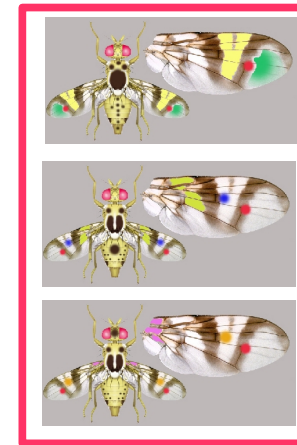

Codificação & Evidência de grupos

Fenética:

EVIDÊNCIAS: similaridade global

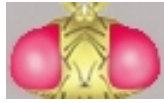

Cladística:

EVIDÊNCIAS: séries de transformações

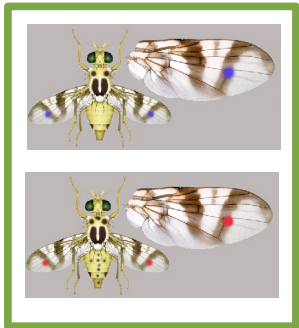
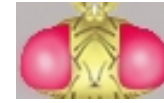

E

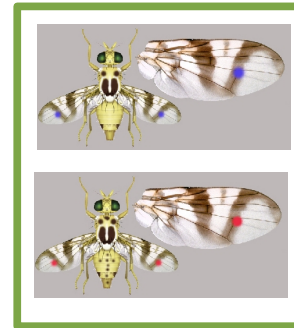
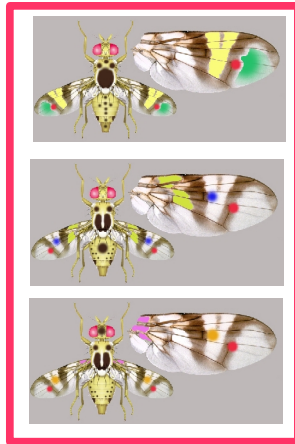

OU

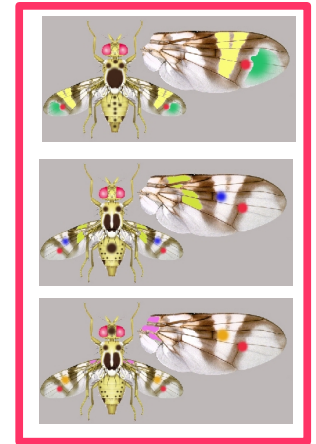

Caracteres & estados de caráter:

Hennig (1966):

CARÁTER



série de transformação



conjunto de condições mutuamente exclusivas

Estados de caráter são conceitualmente definidos como indivíduos históricos menos inclusivos resultado de eventos de transformação hereditários.



É comum definir conceitualmente estados de caráter como elementos puramente observacionais, mas eles são hipóteses de identidade histórica complexas dependente de teoria (descendência com modificação) – não menos hipotéticas que caracteres e outros indivíduos históricos mais inclusivos dos quais fazem parte.

Lógica da inferência filogenética:

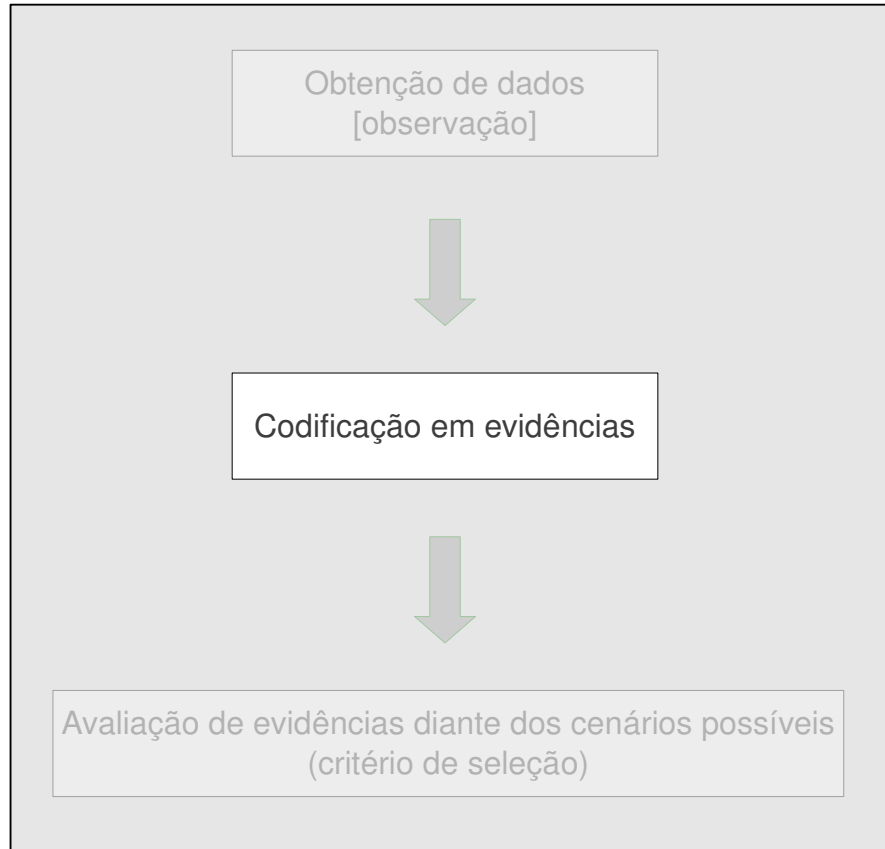
Considere:



Caráter 1: coloração do olho

Estados: 0 = verde 
1 = rosa 

Caráter binário: 0 \longleftrightarrow 1



	C_1
Z	0
A	1
B	1
C	1
D	0

Lógica da inferência filogenética

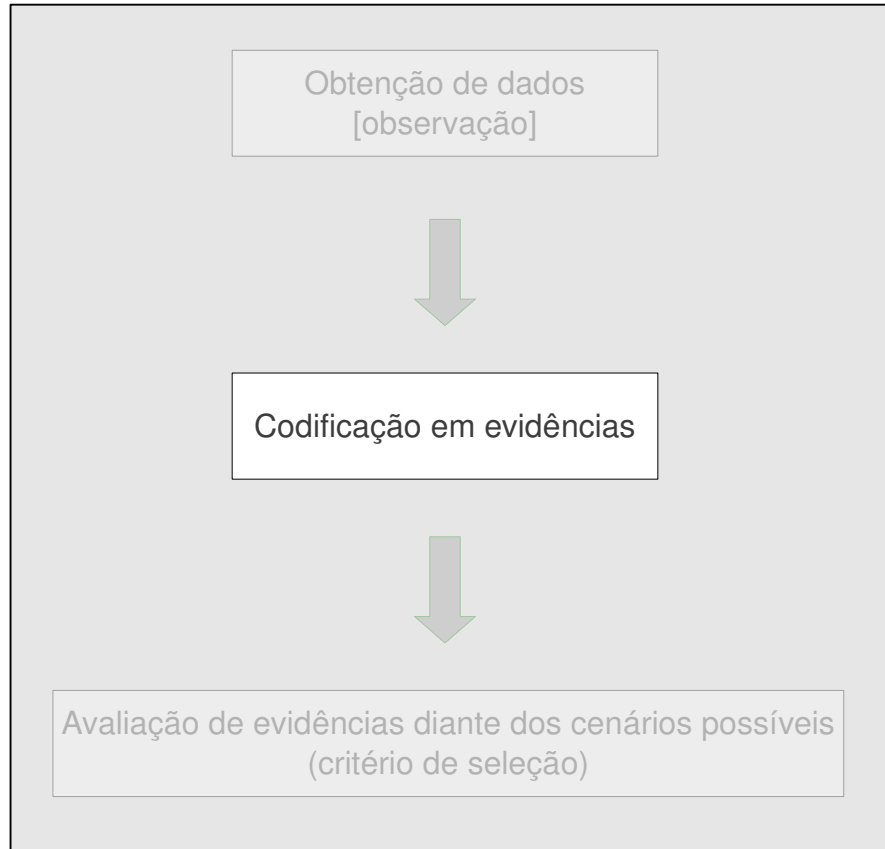
Considere:



Caráter 2: mancha cefálica

Estados: 0 = presente 
 1 = ausente 

Caráter binário: 0 \longleftrightarrow 1



	C ₁	C ₂
Z	0	1
A	1	1
B	1	0
C	1	1
D	0	1

Lógica da inferência filogenética

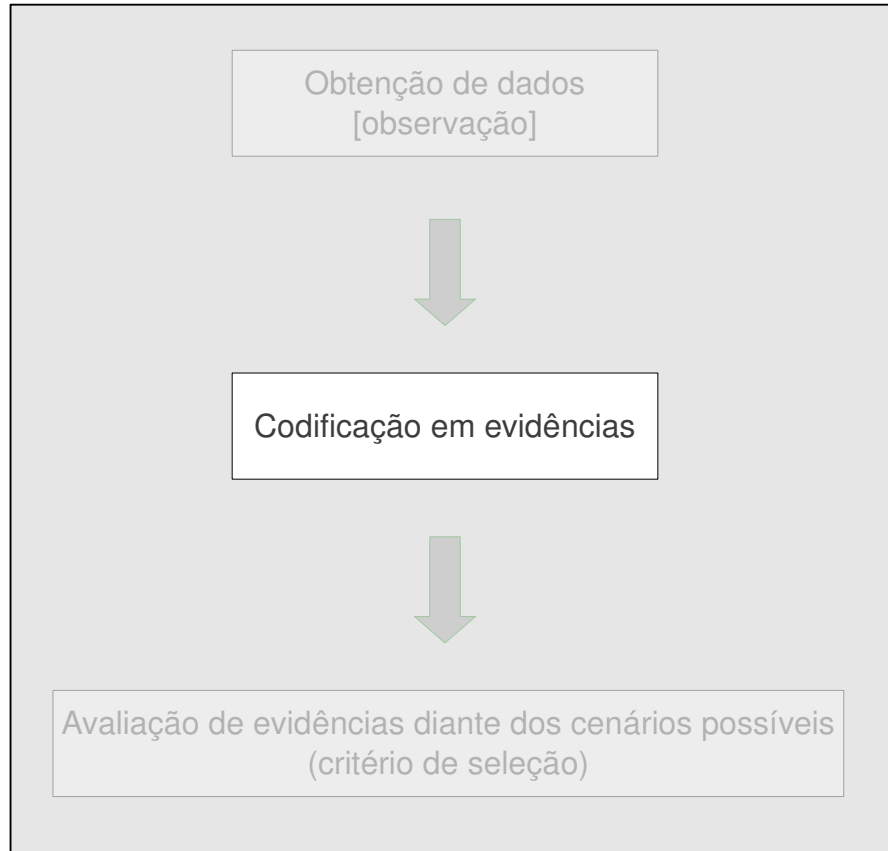
Considere:



Caráter 3: mancha post. torácica

Estados: 0 =  1 = 

2 = 

Caráter multiestado: 0 \longleftrightarrow 1
 $\swarrow \searrow$
 2



	C ₁	C ₂	C ₃
Z	0	1	0
A	1	1	1
B	1	0	1
C	1	1	2
D	0	1	1

Lógica da inferência filogenética

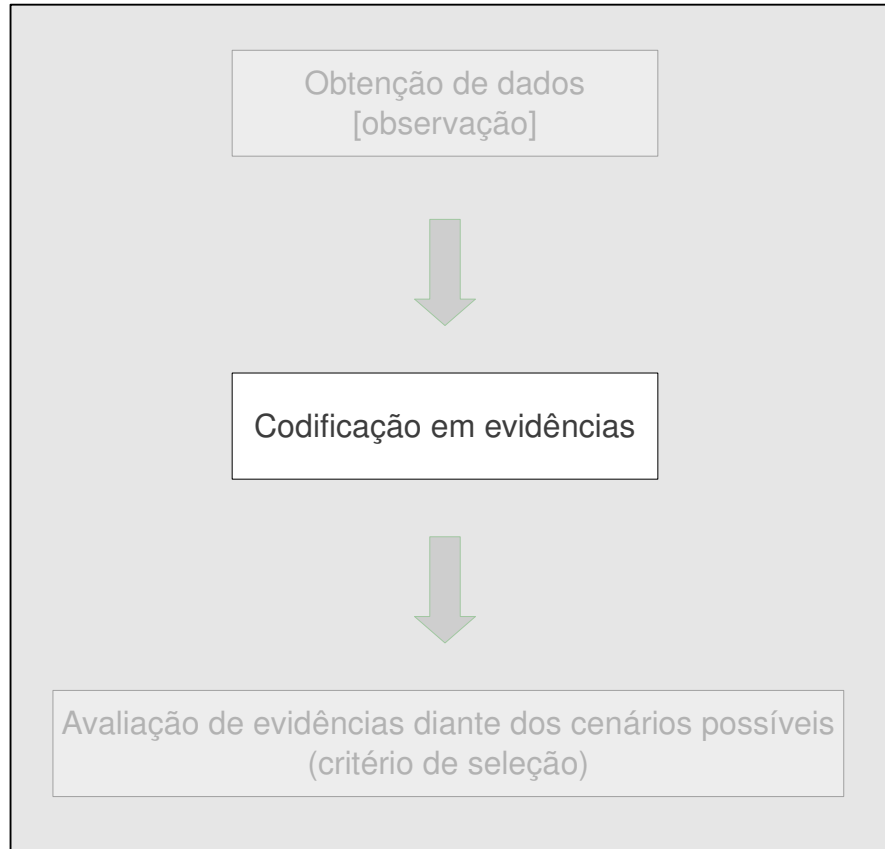
Considere:



Caráter 4: mancha ant/lat torácica

Estados: 0 = ausente 
 1 = presente 

Caráter binário: 0 \longleftrightarrow 1



	C ₁	C ₂	C ₃	C ₄
Z	0	1	0	0
A	1	1	1	1
B	1	0	1	1
C	1	1	2	1
D	0	1	1	1

Lógica da inferência filogenética

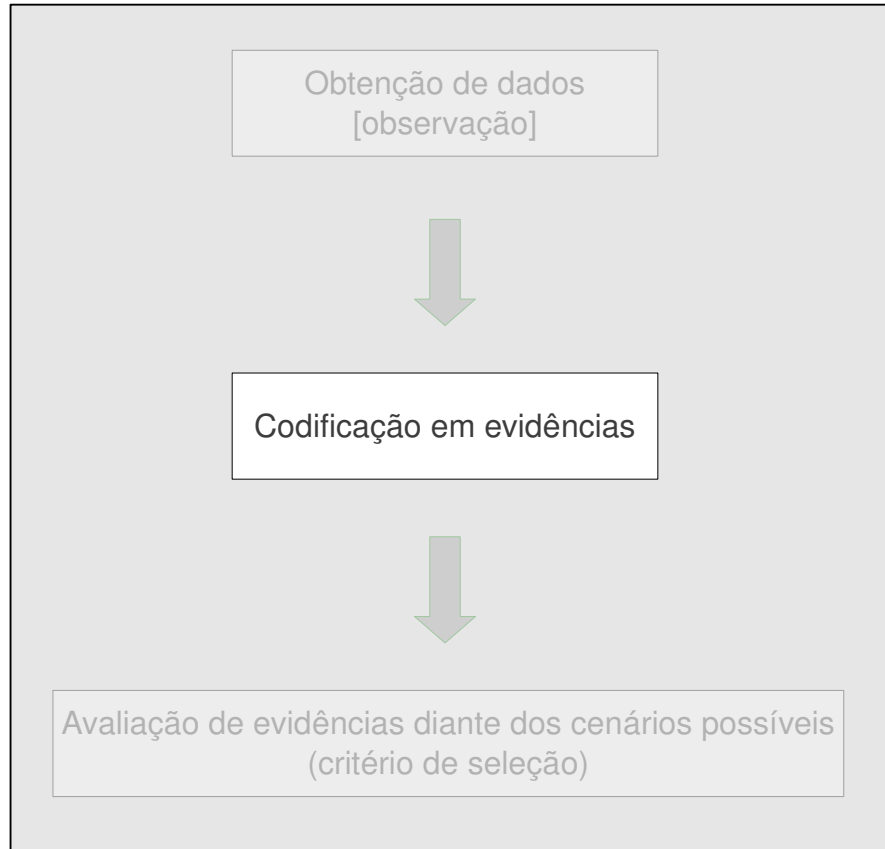
Considere:



Caráter 5: mancha ant. torácica

Estados: 0 = ausente 
 1 = presente 

Caráter binário: 0 \longleftrightarrow 1



	C ₁	C ₂	C ₃	C ₄	C ₅
Z	0	1	0	0	0
A	1	1	1	1	0
B	1	0	1	1	0
C	1	1	2	1	1
D	0	1	1	1	1

Lógica da inferência filogenética

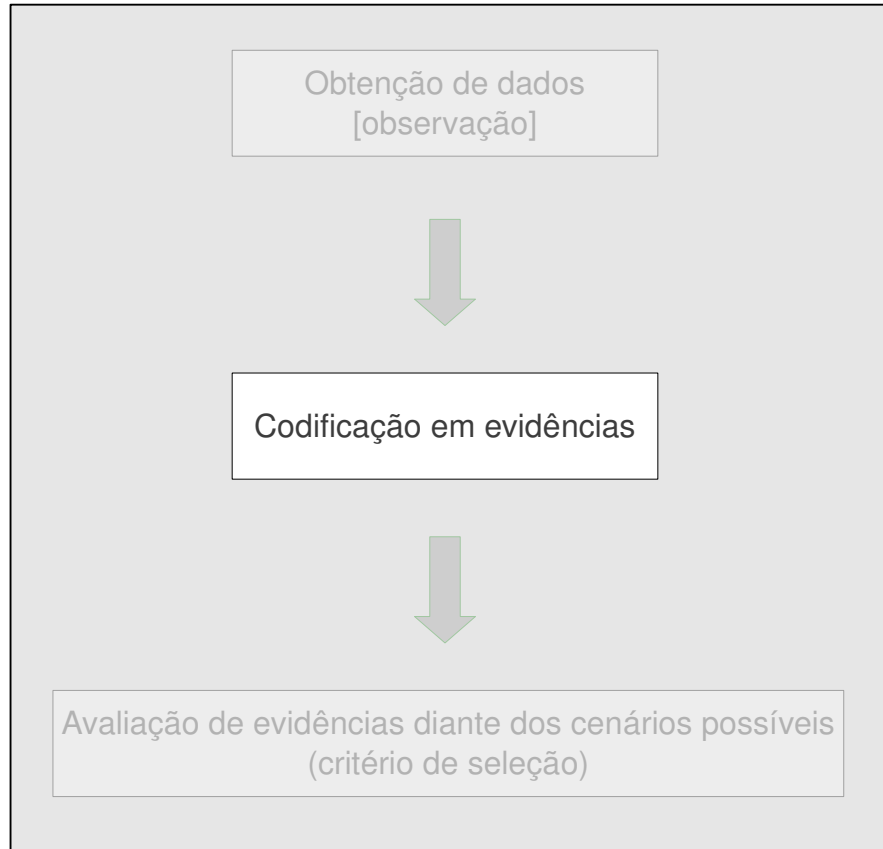
Considere:



Caráter 6: Pigmt. prox. asa

Estados: 0 = ausente 
 1 = presente 

Caráter binário: 0 \longleftrightarrow 1

	C ₁	C ₂	C ₃	C ₄	C ₅	C ₆
Z	0	1	0	0	0	0
A	1	1	1	1	0	0
B	1	0	1	1	0	1
C	1	1	2	1	1	0
D	0	1	1	1	1	0

Lógica da inferência filogenética

Considere:

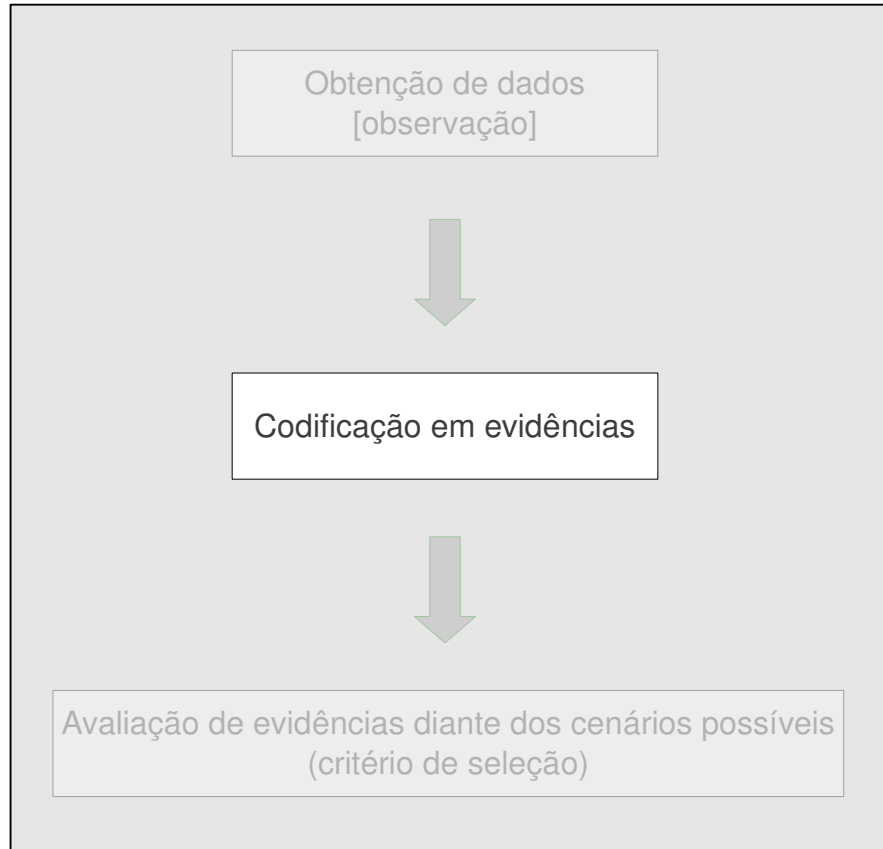

Caráter 7: Pigmt. med.-prox. asa

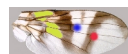
Estados: 0 = ausente 
 1 = presente 

Caráter binário: 0 \longleftrightarrow 1



	C ₁	C ₂	C ₃	C ₄	C ₅	C ₆	C ₇
Z	0	1	0	0	0	0	0
A	1	1	1	1	0	0	1
B	1	0	1	1	0	1	0
C	1	1	2	1	1	0	0
D	0	1	1	1	1	0	0

Lógica da inferência filogenética

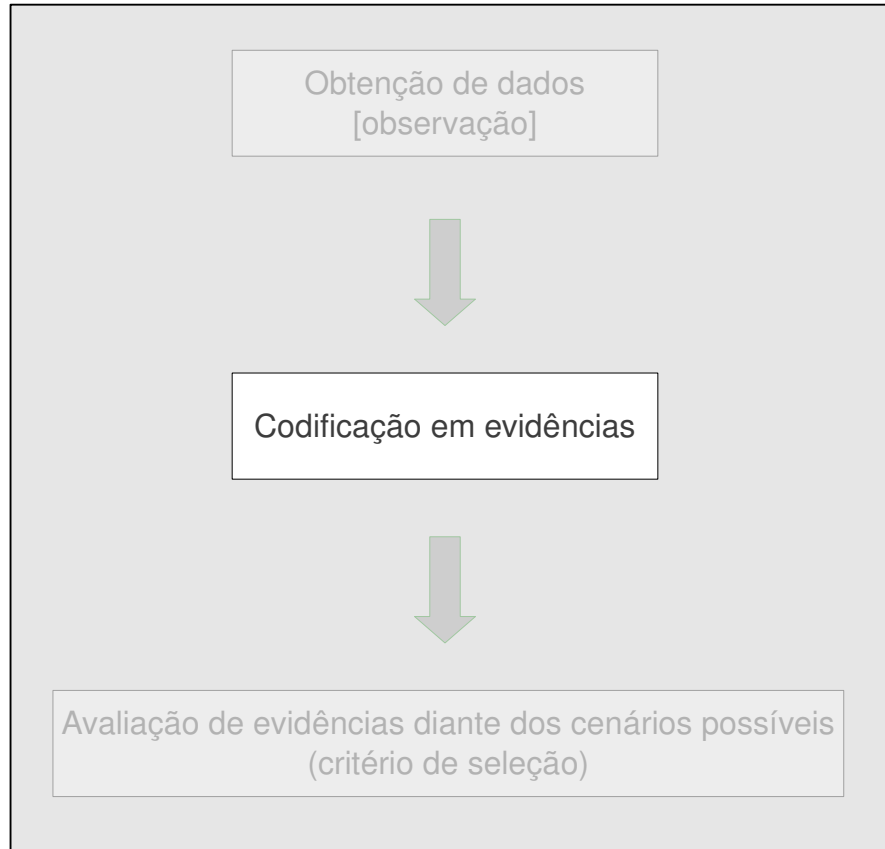
Considere:



Caráter 8: Pigmt. med.-dist. asa

Estados: 0 = ausente 
 1 = presente 

Caráter binário: 0 \longleftrightarrow 1



	C ₁	C ₂	C ₃	C ₄	C ₅	C ₆	C ₇	C ₈
Z	0	1	0	0	0	0	0	0
A	1	1	1	1	0	0	1	0
B	1	0	1	1	0	1	0	0
C	1	1	2	1	1	0	0	1
D	0	1	1	1	1	0	0	0

Lógica da inferência filogenética

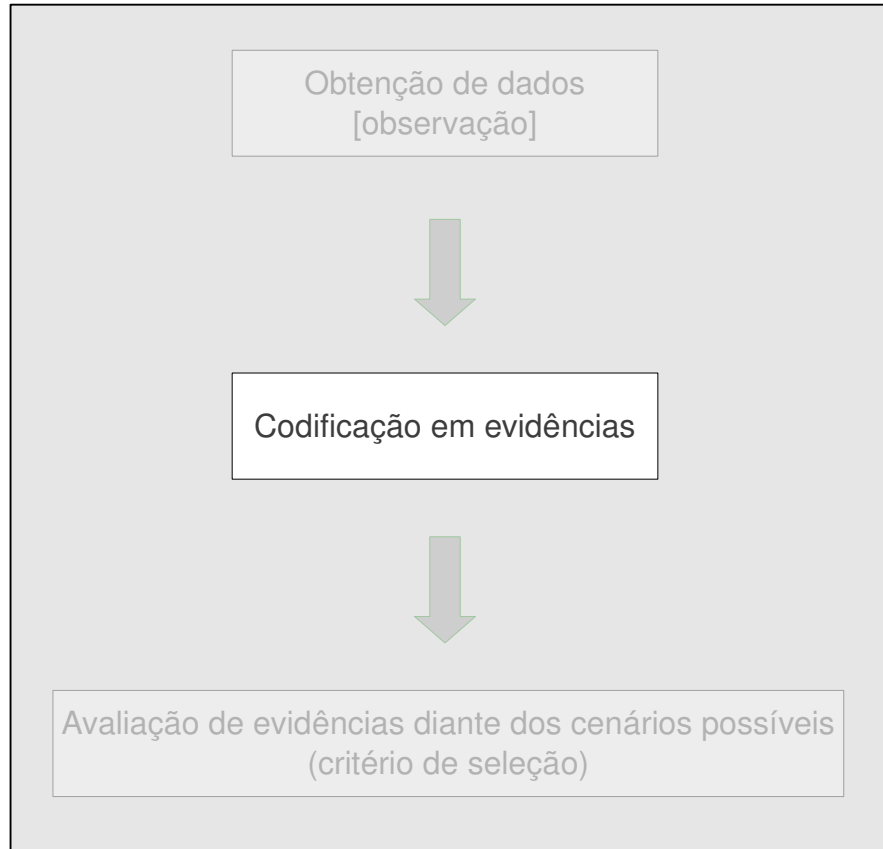
Considere:



Caráter 9: Pigmt. distal na asa

Estados: 0 = ausente 
 1 = presente 

Caráter binário: 0 \longleftrightarrow 1



	C ₁	C ₂	C ₃	C ₄	C ₅	C ₆	C ₇	C ₈	C ₉
Z	0	1	0	0	0	0	0	0	0
A	1	1	1	1	0	0	1	0	0
B	1	0	1	1	0	1	0	0	0
C	1	1	2	1	1	0	0	1	1
D	0	1	1	1	1	0	0	0	0

Lógica da inferência filogenética

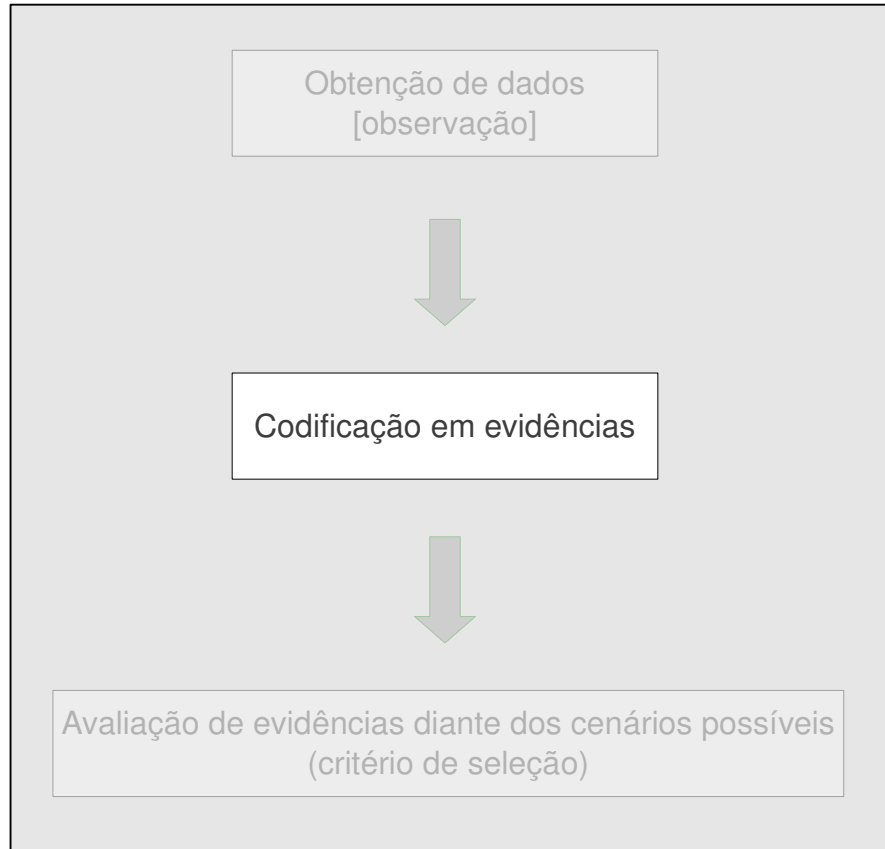
Considere:



Caráter 10: Mancha no ovopositor

Estados: 0 = ausente 
 1 = presente 

Caráter binário: 0 \longleftrightarrow 1



	C ₁	C ₂	C ₃	C ₄	C ₅	C ₆	C ₇	C ₈	C ₉	C ₁₀
Z	0	1	0	0	0	0	0	0	0	0
A	1	1	1	1	0	0	1	0	0	0
B	1	0	1	1	0	1	0	0	0	0
C	1	1	2	1	1	0	0	1	1	1
D	0	1	1	1	1	0	0	0	0	1

Lógica da inferência filogenética

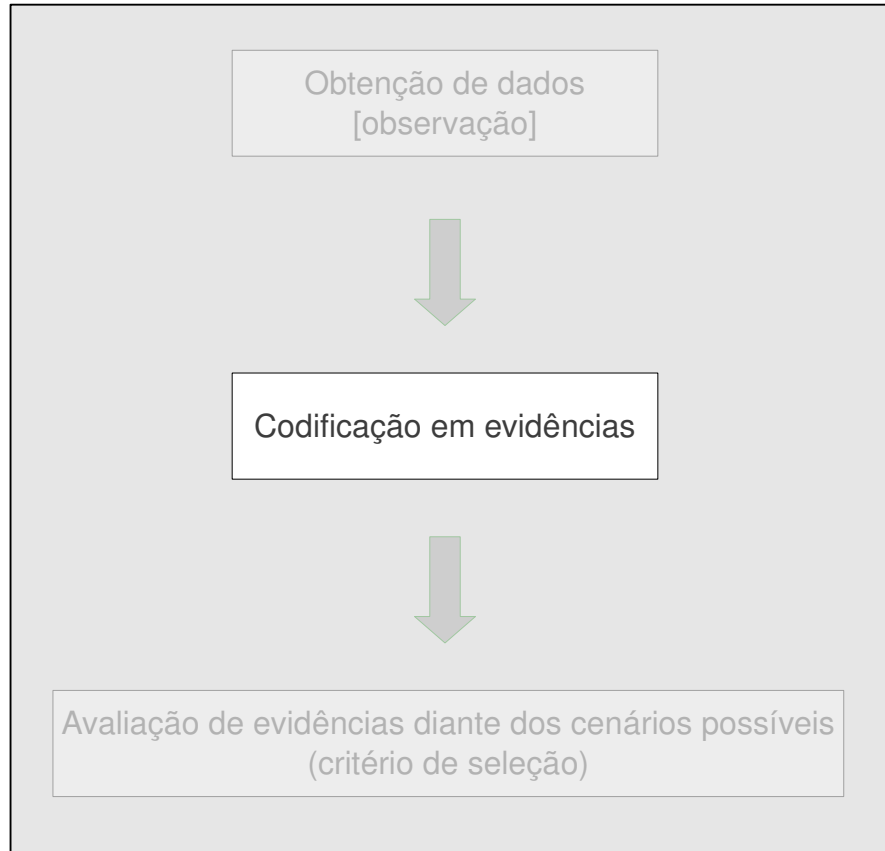
Considere:



Caráter 11: Manchas em cruz abd.

Estados: 0 = ausente 
 1 = presente 

Caráter binário: 0 \longleftrightarrow 1



	C ₁	C ₂	C ₃	C ₄	C ₅	C ₆	C ₇	C ₈	C ₉	C ₁₀	C ₁₁
Z	0	1	0	0	0	0	0	0	0	0	0
A	1	1	1	1	0	0	1	0	0	0	0
B	1	0	1	1	0	1	0	0	0	0	0
C	1	1	2	1	1	0	0	1	1	1	1
D	0	1	1	1	1	0	0	0	0	1	1

Lógica da inferência filogenética

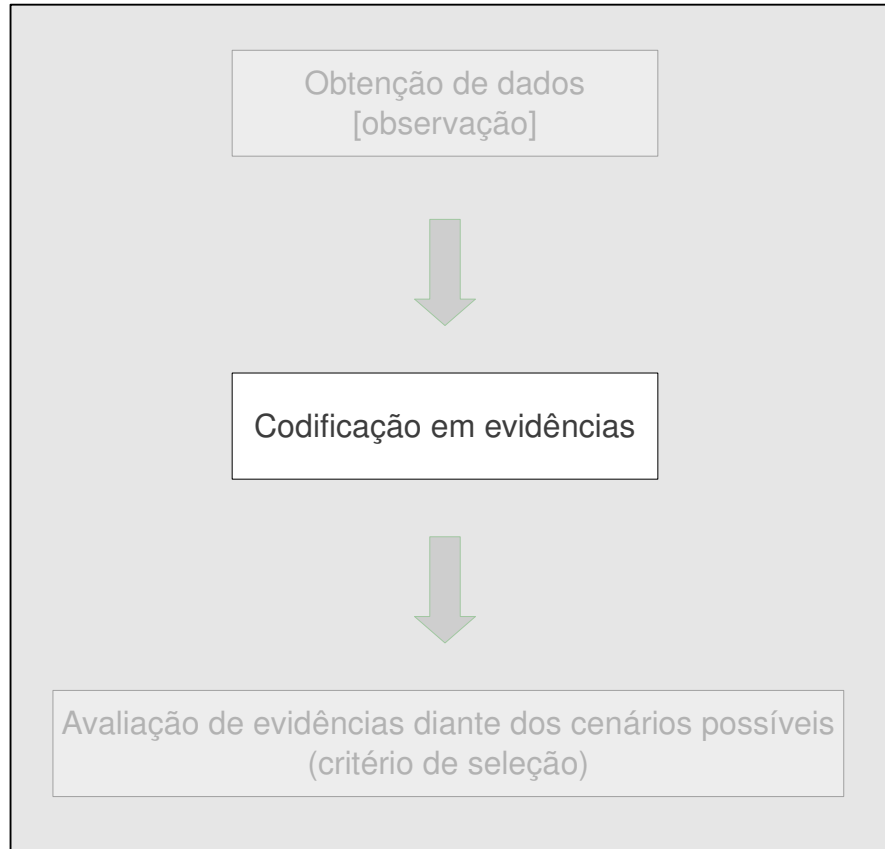
Considere:



Caráter 12: Manchas laterais abd.

Estados: 0 = ausente 
 1 = presente 

Caráter binário: 0 \longleftrightarrow 1

	C ₁	C ₂	C ₃	C ₄	C ₅	C ₆	C ₇	C ₈	C ₉	C ₁₀	C ₁₁	C ₁₂
Z	0	1	0	0	0	0	0	0	0	0	0	0
A	1	1	1	1	0	0	1	0	0	0	0	1
B	1	0	1	1	0	1	0	0	0	0	0	1
C	1	1	2	1	1	0	0	1	1	1	1	0
D	0	1	1	1	1	0	0	0	0	1	1	0

Lógica da inferência filogenética

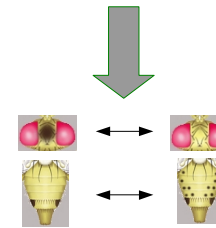
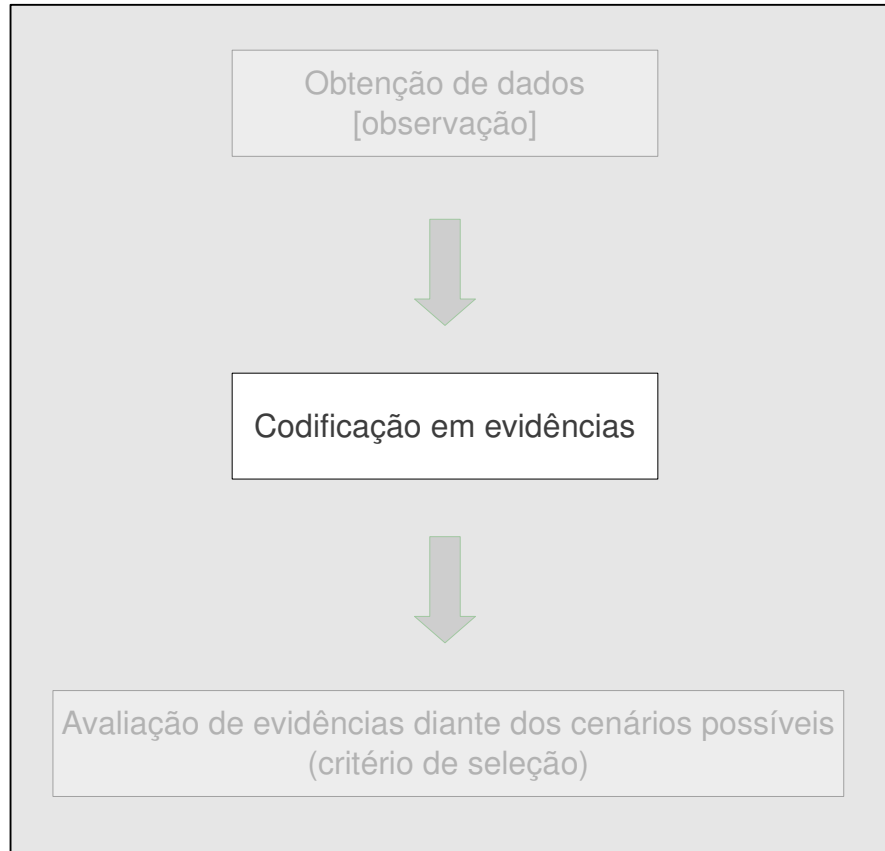

Compilação de dados observacionais

Definição de caráter e estados de caráter

Codificação de matriz de dados

MATRIX DE TRANSFORMAÇÃO

	C ₁	C ₂	C ₃	C ₄	C ₅	C ₆	C ₇	C ₈	C ₉	C ₁₀	C ₁₁	C ₁₂
Z	0	1	0	0	0	0	0	0	0	0	0	0
A	1	1	1	1	0	0	1	0	0	0	0	1
B	1	0	1	1	0	1	0	0	0	0	0	1
C	1	1	2	1	1	0	0	1	1	1	1	0
D	0	1	1	1	1	0	0	0	0	1	1	0



Codificação: caracteres e estados de caráter

Definição de caráter
e estados de caráter





Codificação de
matriz de dados

Caráter 1: coloração do olho

Estados: 0 = verde 
1 = rosa 

Caráter 3: mancha post. torácica





Estados: 0 =  1 =  2 = 

	C_1	C_3
Z	0	0
A	1	1
B	1	1
C	1	2
D	0	1



Assume-se que os estados são eventos de transformação histórica e que sua distribuição está relacionada com ancestralidade.

Codificação: caracteres e estados de caráter

Considere:

Z 
A 
B 
C 
D 

Caráter 3: mancha post. torácica

Estados: 0 =  1 =  2 = 

Caráter 4: mancha ant/lat torácica





Estados: 0 = ausente  1 = presente 

Caráter 5: mancha ant. torácica

Estados: 0 = ausente  1 = presente 

VS.

Caráter **X**: Pigmentação torácica

Estados: 0 =  1 =  2 =  3 = 



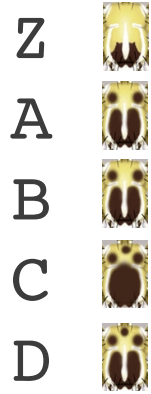

Observe que o conjunto de estados é abstrato e que cada um implica em uma série de transformação distinta.

Série de transformações

Considere:



Caráter **X**: Pigmentação torácica

Estados: 0 =  1 =  2 =  3 = 

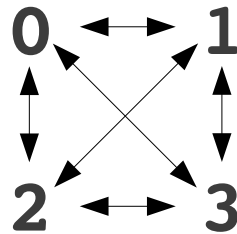

Série de transf. não-ordenada

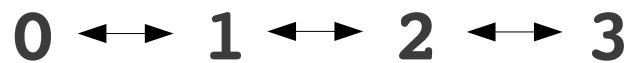

Série de transf. ordenada

Relação de adjacência entre os estados.



Série de transf. Polarizada

Direcionalidade da transformação.

Lógica da inferência filogenética

Avaliação e critério de seleção: soluções possíveis

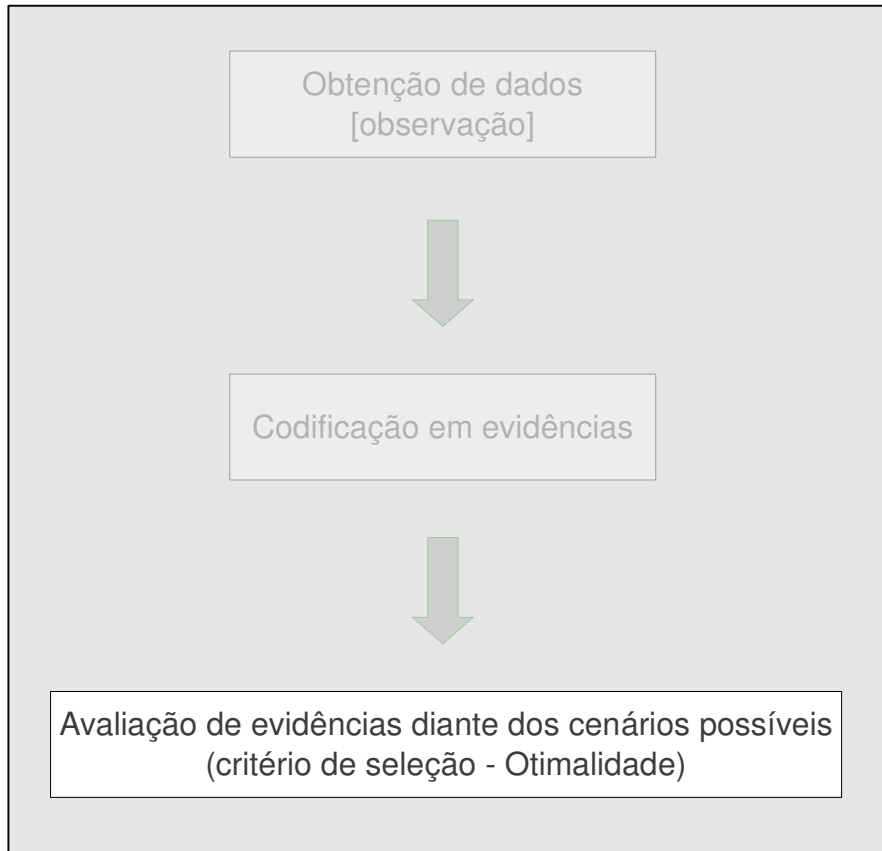

	C ₁	C ₂	C ₃	C ₄	C ₅	C ₆	C ₇	C ₈	C ₉	C ₁₀	C ₁₁	C ₁₂
Z	0	1	0	0	0	0	0	0	0	0	0	0
A	1	1	1	1	0	0	1	0	0	0	0	1
B	1	0	1	1	0	1	0	0	0	0	0	1
C	1	1	2	1	1	0	0	1	1	1	1	0
D	0	1	1	1	1	0	0	0	0	1	1	0

Número de Cenários = $(2n-5)!/[2^{n-3}*(n-3)!]$

onde n é igual ao número de terminais (OTUs).

No. de OTUs	No. de Soluções
3	1
4	3
5	15
6	105
...	...

Qual topologia explica melhor a variabilidade hereditária observada?

Topologias:

Topologia: refere-se às conexões entre vértices e arestas.

Em inferência filogenética o termo refere-se a diagramas dicotômicos que postulam diferentes relações entre os terminais.

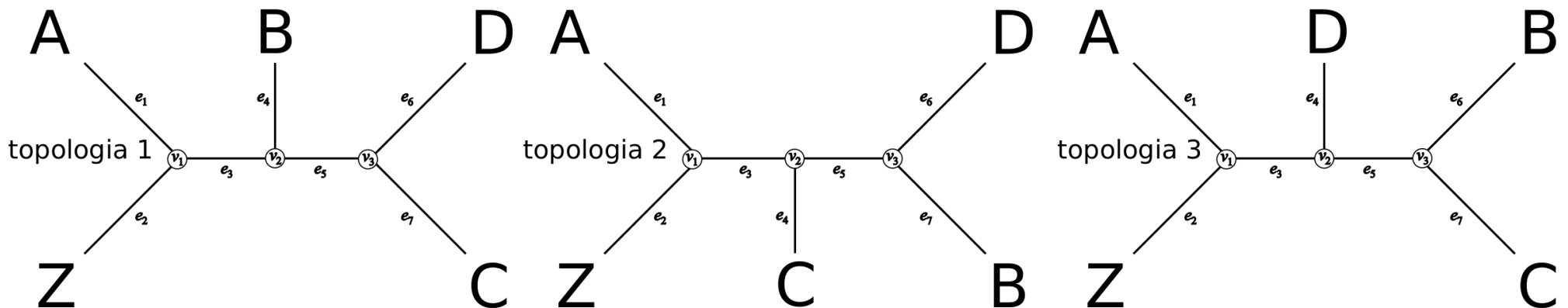

Topologias:

O termo refere-se a diagramas dicotômicos que postulam diferentes relações entre os terminais.

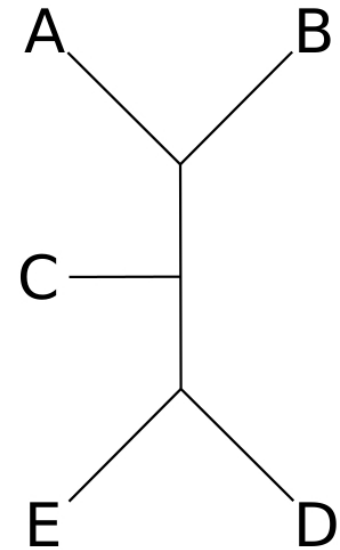
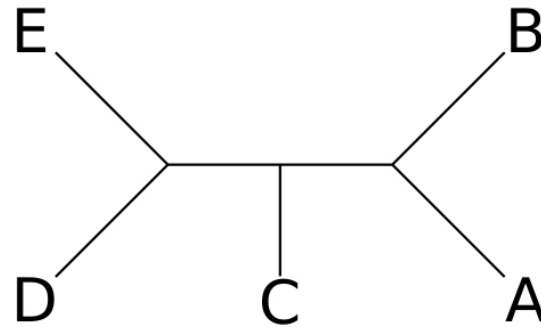
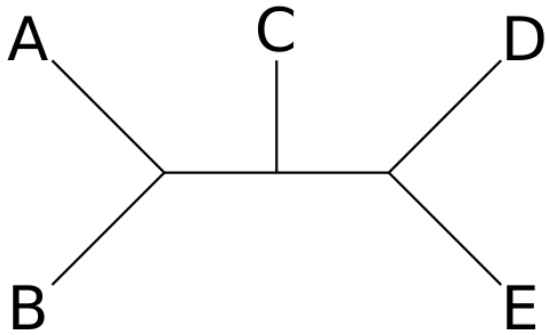

Quantas topologias temos aqui?

Topologias:

O termo refere-se a diagramas dicotômicos que postulam diferentes relações entre os terminais.

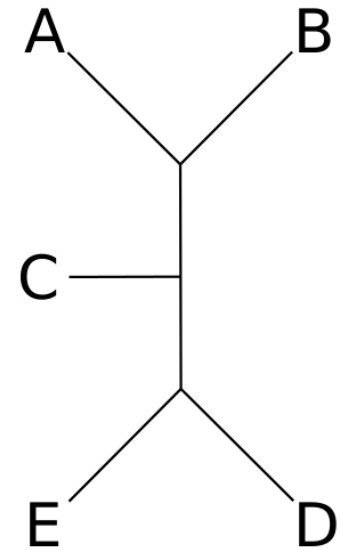
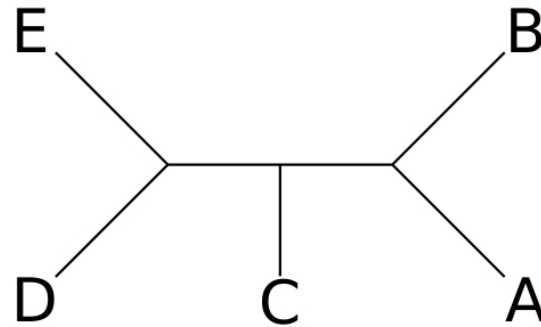
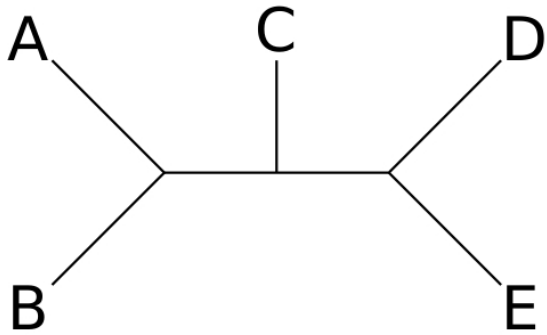

Quantas topologias temos aqui?

R: Uma!

Topologias:

Topologia 1

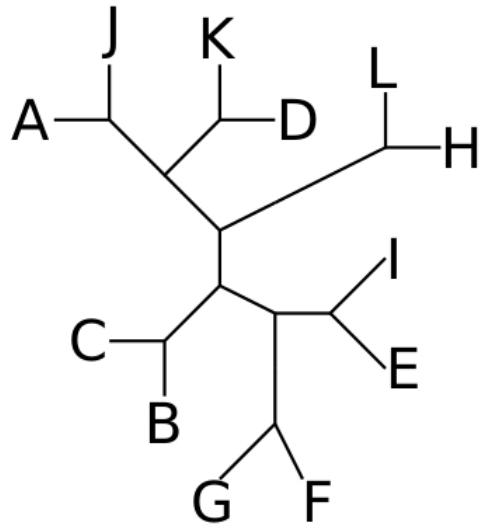

Topologia 2

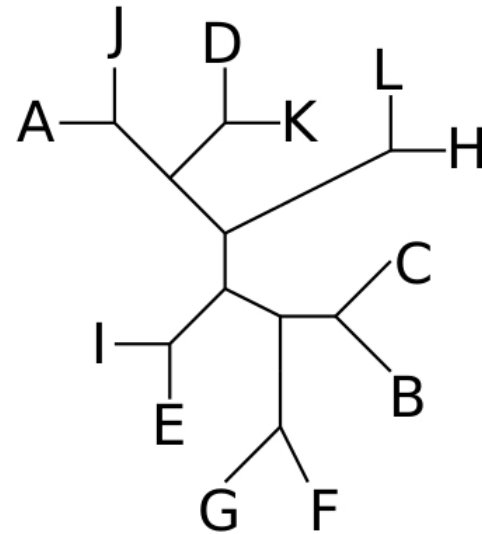

Topologia 3

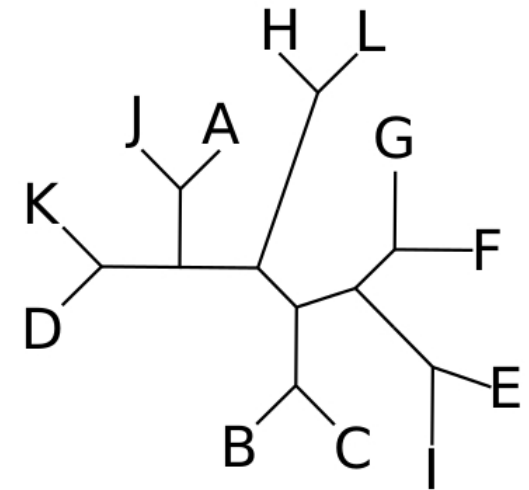

Quantas topologias temos aqui?

Topologias:

Topologia 1

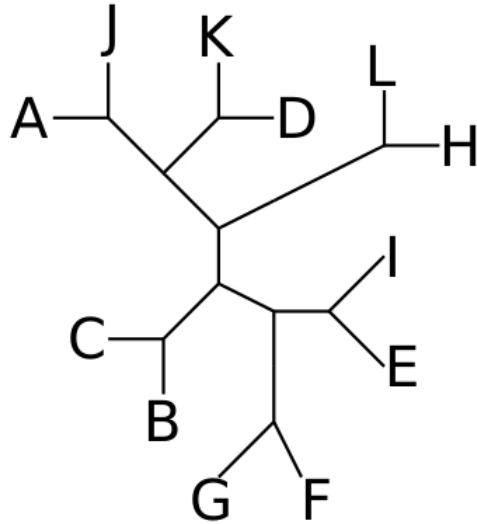

Topologia 2

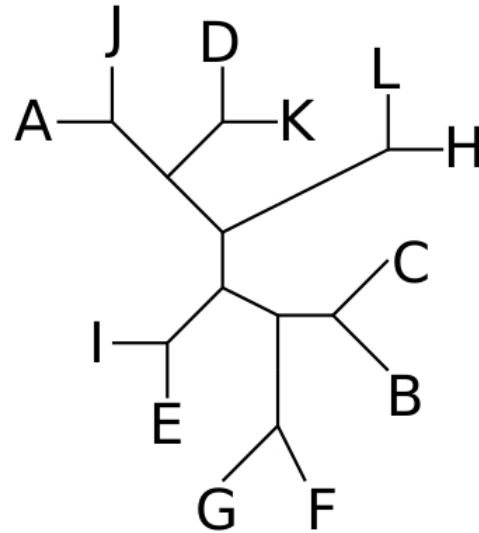

Topologia 3

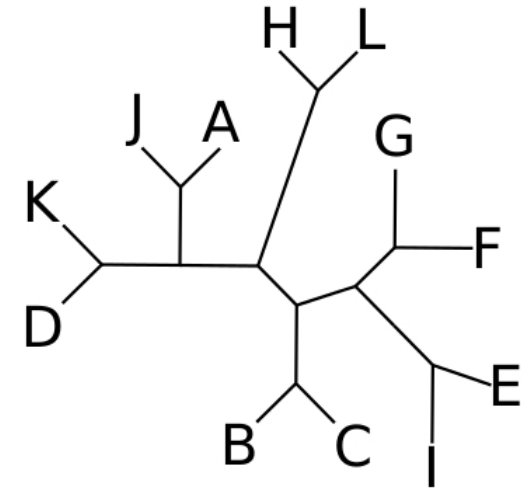

Quantas topologias temos aqui?

R: Duas! Topologia 1 = Topologia 3

Enumeração:

3 1
4 3 Para topologias não direcionadas e $n \geq 3$:
5 15

6 105
7 945
8 10395
9 135135
10 2027025
11 34459425
12 654729075
13 13749310575
14 316234143225
15 7905853580625
16 213458046676875
17 6190283353629375
18 191898783962510625
19 6332659870762850625
20 221643095476699771875
21 8200794532637891559375
22 319830986772877770815625
23 13113070457687988603440625
24 563862029680583509947946875
25 25373791335626257947657609375
26 1192568192774434123539907640625
27 58435841445947272053455474390625
28 2980227913743310874726229193921875
29 157952079428395476360490147277859375
30 8687364368561751199826958100282265625
31 495179769008019818390136611716089140625
32 29215606371473169285018060091249259296875
33 1782151988659863326386101665566204817109375
34 112275575285571389562324404930670903477890625
35 7297912393562140321551086320493608726062890625
36 488960130368663401543922783473071784646213671875
37 33738248995437774706530672059641953140588743359375
38 2395415678676082004163677716234578672981800778515625
39 174865344543353986303948473285124243127671456831640625
40 13114900840751548972796135496384318234575359262373046875

$$\frac{(2n - 4)!}{(n - 2)! 2^{n-2}}$$

O número de topologias enraizadas pode ser calculado multiplicando a fórmula acima pelo número de ramos $(2n-3)$ ou incrementando $+1$ à n .

Critério de otimização:

Topologias como hipóteses:

Teste → Avaliação → Determinação de qualidade relativa

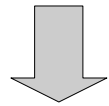

Índices de mérito comparativos

Independente do índice: requer função objetiva

$$C = f(D, T)$$

'Without such a cost, these objects are mere pictures — “tree-shaped-objects” of no use in science'
(Wheeler et al., 2006: Cladistics 12:1-9)

Critério de otimização: Cladística

Função objetiva:

$$C = f(D, T)$$

*Menor
distância
patrística* = f (

sp.X	1	3	2	2	1	3	0	1	2	3
sp.A	3	2	2	0	2	3	0	0	2	3
sp.B	1	1	3	0	2	1	0	0	2	3
sp.C	1	1	3	2	0	3	3	2	1	0

;

)

Esta função minimiza o número total de hipóteses de transformação necessária para explicar as observações utilizando o princípio da **parcimônia**.

Lógica da inferência filogenética: critério de seleção

Cladística:

Otimização: refere-se a seleção do melhor elemento de um conjunto disponível de alternativas, Portanto requer **critério**.

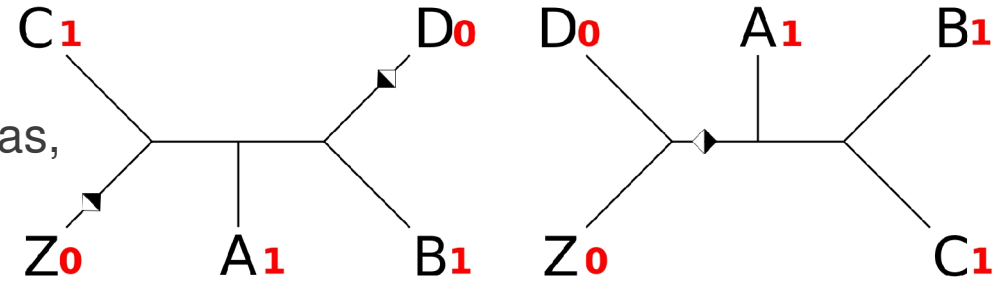

Critério de seleção: **parcimônia**

Beba com PARCIMÔNIA



Lógica da inferência filogenética: critério de seleção

Cladística:

Otimização: refere-se a seleção do melhor elemento de um conjunto disponível de alternativas.

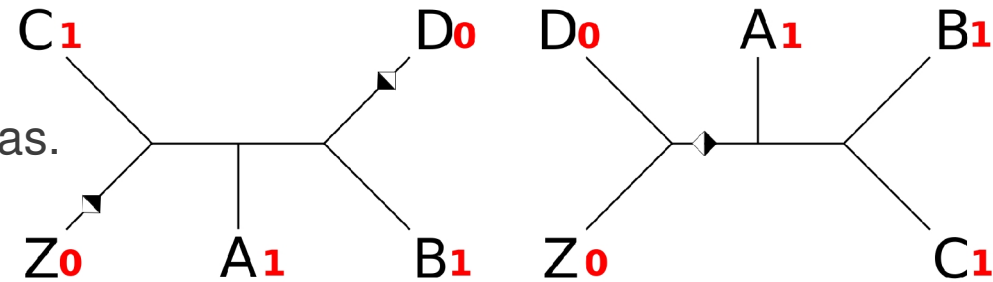

Critério de otimização: **parcimônia**



William of Ockham (c. 1288 - c. 1348): *lex parsimoniae* ou "Occam's Razor"

"entia non sunt multiplicanda praeter necessitatem"

"Entities should not be multiplied unnecessarily."

"when you have two competing theories which make exactly the same predictions, the one that is simpler is the better."

Newton stated the rule: "We are to admit no more causes of natural things than such as are both true and sufficient to explain their appearances."

Lógica da inferência filogenética

Avaliação e critério de seleção: Otimização e conteúdo informativo

	C ₁	C ₂	C ₃	C ₄	C ₅	C ₆	C ₇	C ₈	C ₉	C ₁₀	C ₁₁	C ₁₂
Z	0	1	0	0	0	0	0	0	0	0	0	0
A	1	1	1	1	0	0	1	0	0	0	0	1
B	1	0	1	1	0	1	0	0	0	0	0	1
C	1	1	2	1	1	0	0	1	1	1	1	0
D	0	1	1	1	1	0	0	0	0	1	1	0

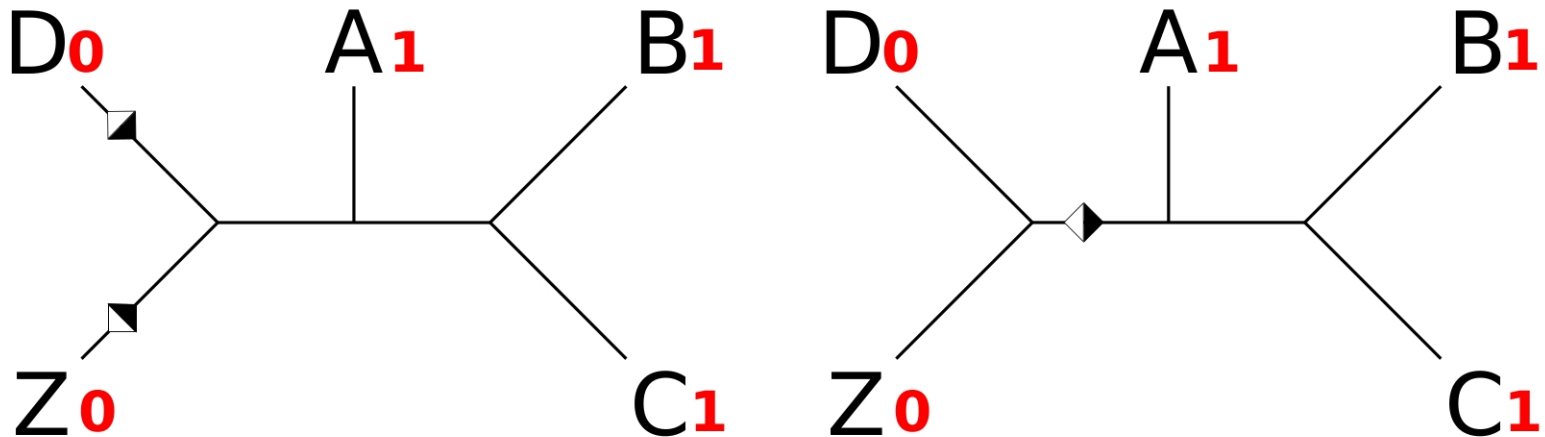

Otimização: refere-se a seleção do melhor elemento de um conjunto disponível de alternativas.

Otimização:

O termo refere-se a seleção do melhor elemento de um conjunto disponível de alternativas.

Se o critério de escolha (parcimônia) visa identificar a topologia com o menor número de transformações, então cada transformação deverá ser otimizada em cada topologia.

Considere:

Terminal		c_1
A	1	1
B	0	0
C	0	0
D	0	0
E	0	0
F	1	1
G	0	0
H	0	0
I	0	0
J	1	1
K	0	0
L	0	0

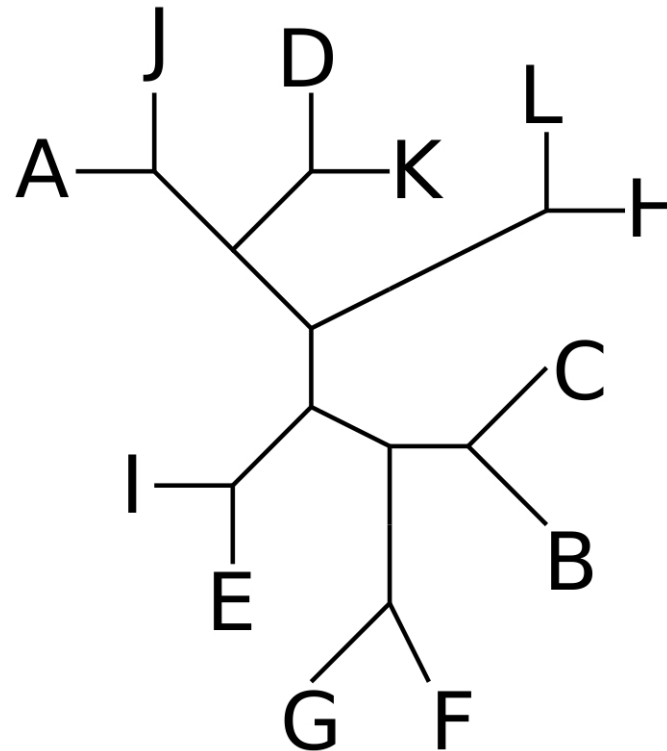

Onde as transformações ocorreram?

Otimização:

O termo refere-se a seleção do melhor elemento de um conjunto disponível de alternativas.

Se o critério de escolha (parcimônia) visa identificar a topologia com o menor número de transformações, então cada transformação deverá ser otimizada em cada topologia.

Considere:

Terminal		c_1
A	1	1
B	0	0
C	0	0
D	0	0
E	0	0
F	1	1
G	0	0
H	0	0
I	0	0
J	1	1
K	0	0
L	0	0

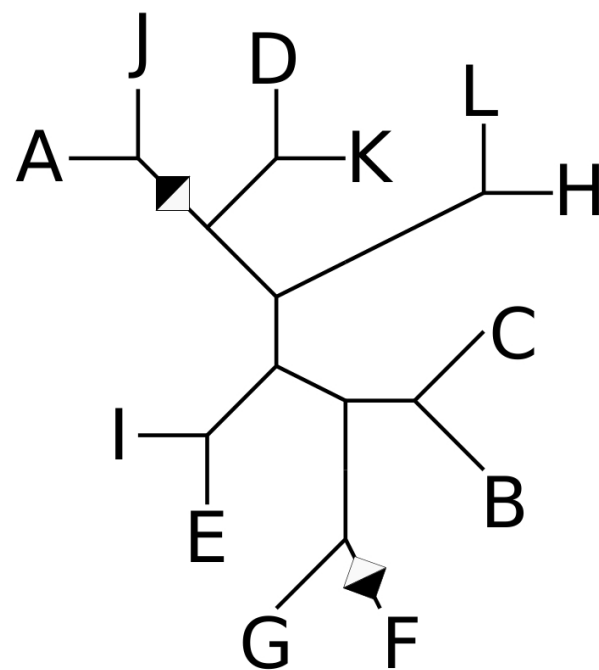
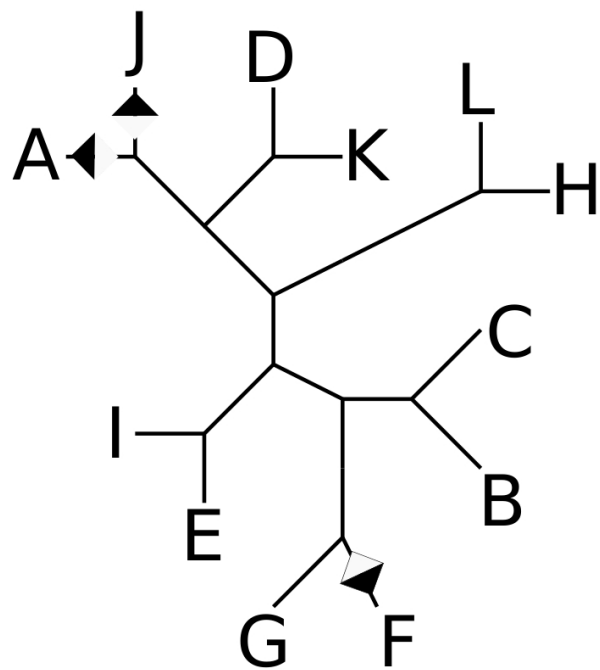

Qual destas opções faz mais sentido?

Otimização:

Casos um pouco mais complexos:

Considere:

	c_1
Terminal A	0
Terminal B	1
Terminal C	1
Terminal D	0
Terminal E	1
Terminal F	0
Terminal G	0
Terminal H	0
Terminal I	1
Terminal J	0
Terminal K	0
Terminal L	0

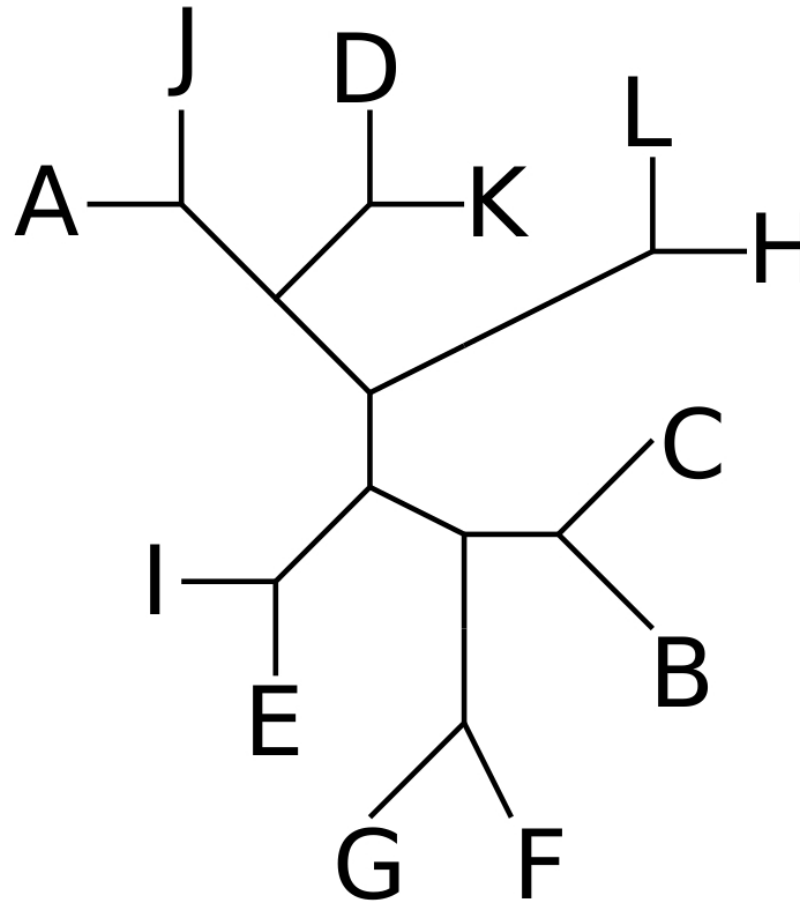

Onde as transformações ocorreram?

Otimização:

Casos um pouco mais complexos:

Considere:

	c_1
Terminal A	0
Terminal B	1
Terminal C	1
Terminal D	0
Terminal E	1
Terminal F	0
Terminal G	0
Terminal H	0
Terminal I	1
Terminal J	0
Terminal K	0
Terminal L	0

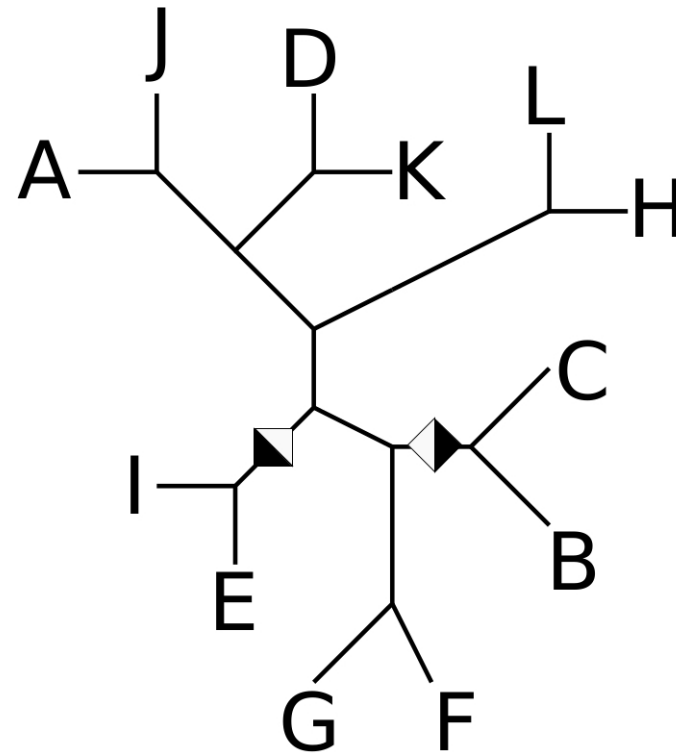

Onde as transformações ocorreram? Em dois ramos, mas ...

Otimização:

Casos um pouco mais complexos:

Considere:

	c_1
Terminal A	0
Terminal B	1
Terminal C	1
Terminal D	0
Terminal E	1
Terminal F	0
Terminal G	0
Terminal H	0
Terminal I	1
Terminal J	0
Terminal K	0
Terminal L	0

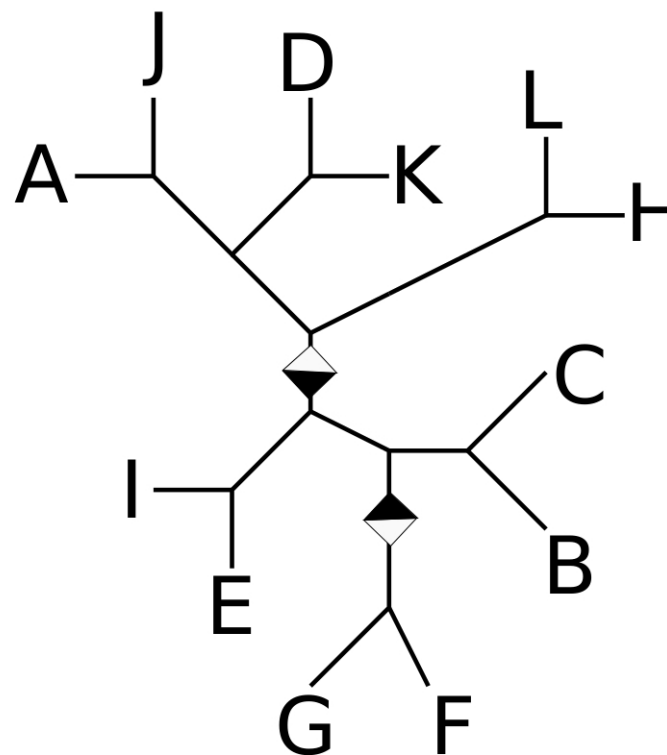

Em dois ramos, mas podem ser explicadas de duas maneiras.

Otimização:

Casos um pouco mais complexos:

Considere:

	c_1
Terminal A	0
Terminal B	1
Terminal C	1
Terminal D	0
Terminal E	1
Terminal F	0
Terminal G	0
Terminal H	0
Terminal I	1
Terminal J	0
Terminal K	0
Terminal L	0

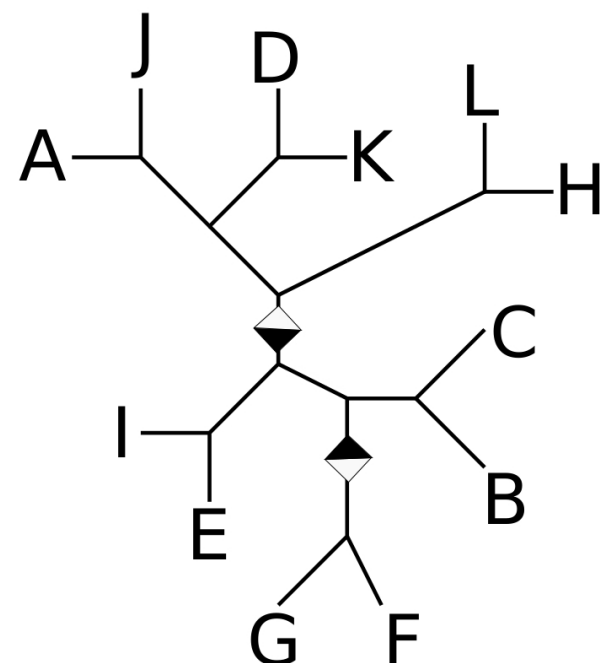
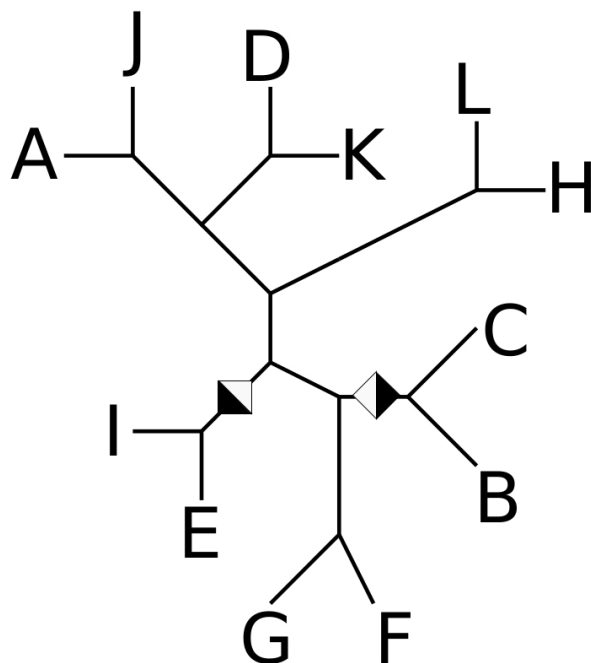

Otimizações igualmente parcimoniosas.

Critério de otimalidade: Hipóteses & evidência

Como expressamos hipóteses filogenéticas?

O que são evidências e quais utilizamos?

Critério de otimalidade: Hipóteses & evidência

Topologias como hipóteses:

Teste → Avaliação → Determinação de qualidade relativa

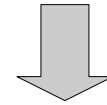

Índices de mérito comparativos

↓ ↓ ↓
sp.X C T G G C T A C G T
sp.A T G G A G T A A G T
sp.B C C T A G C A A G T
sp.C C C T G A T T G C A



Cladística:

EVIDÊNCIAS: transformação de estados de caracteres

1a. posição: C ↔ T
3a. posição: G ↔ T
10a. posição: T ↔ A



CODIFICAÇÃO: matriz de dados

	c ₁	c ₂	c ₃	c ₄	c ₅	c ₆	c ₇	c ₈	c ₉	c ₁₀
sp.X	1	3	2	2	1	3	0	1	2	3
sp.A	3	2	2	0	2	3	0	0	2	3
sp.B	1	1	3	0	2	1	0	0	2	3
sp.C	1	1	3	2	0	3	3	2	1	0

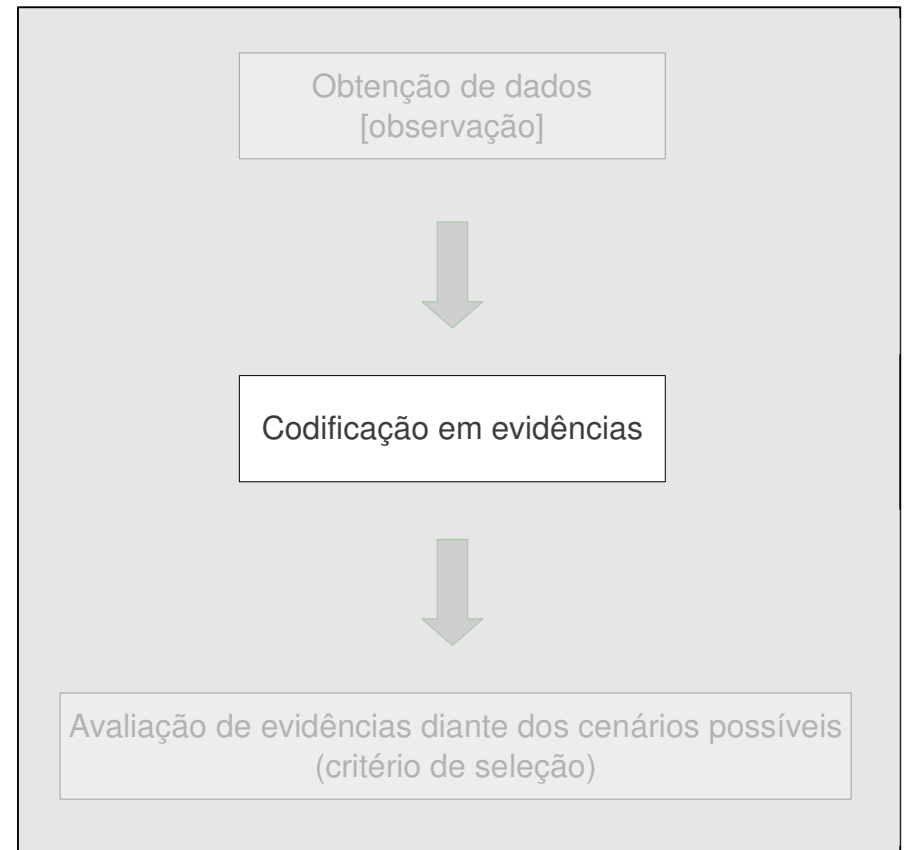

Lógica da inferência filogenética

Otimização e conteúdo informativo (**evidencial**)

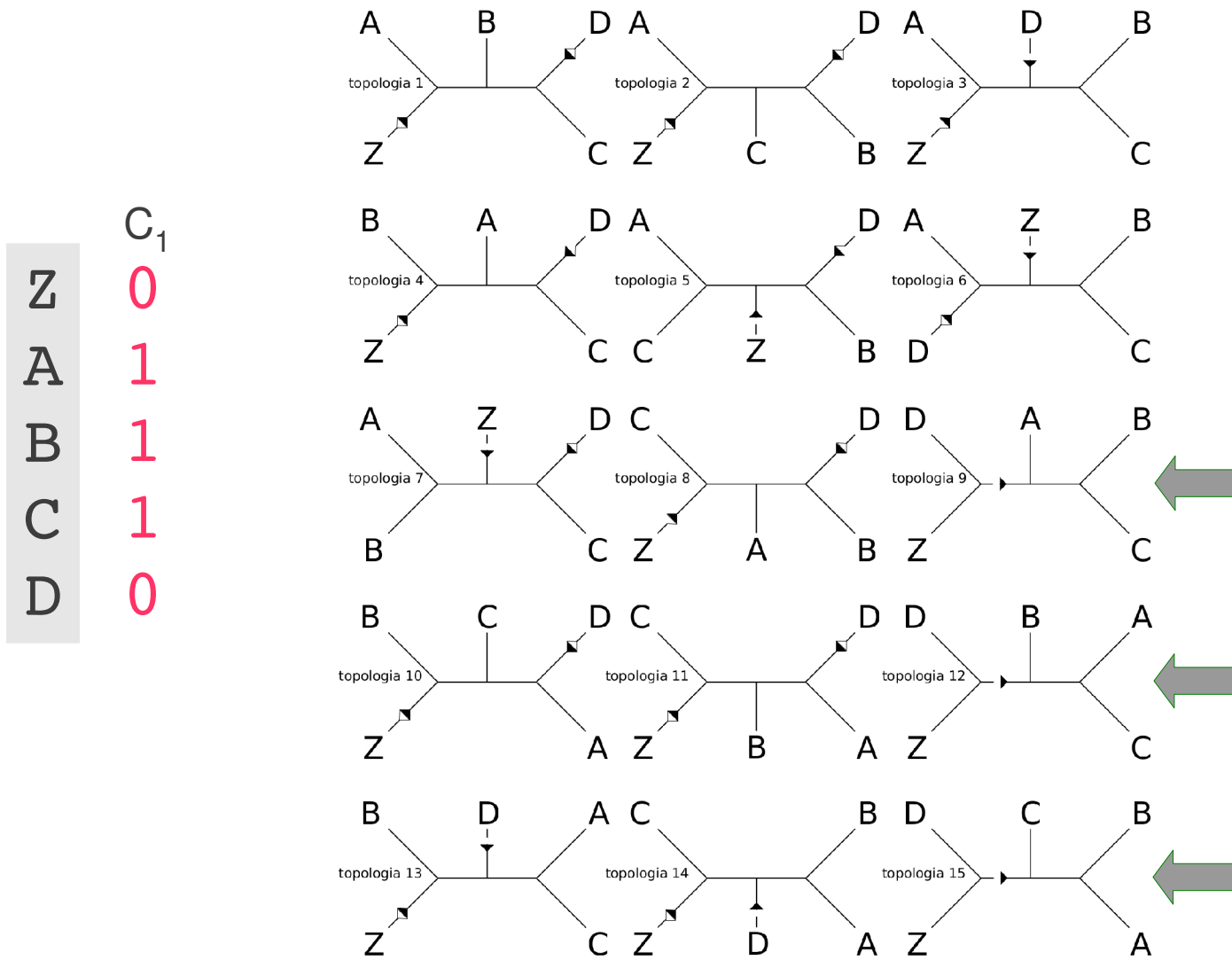

uma transformação
vs.
duas transformações

Caráter informativo!

Lógica da inferência filogenética

Otimização e conteúdo informativo

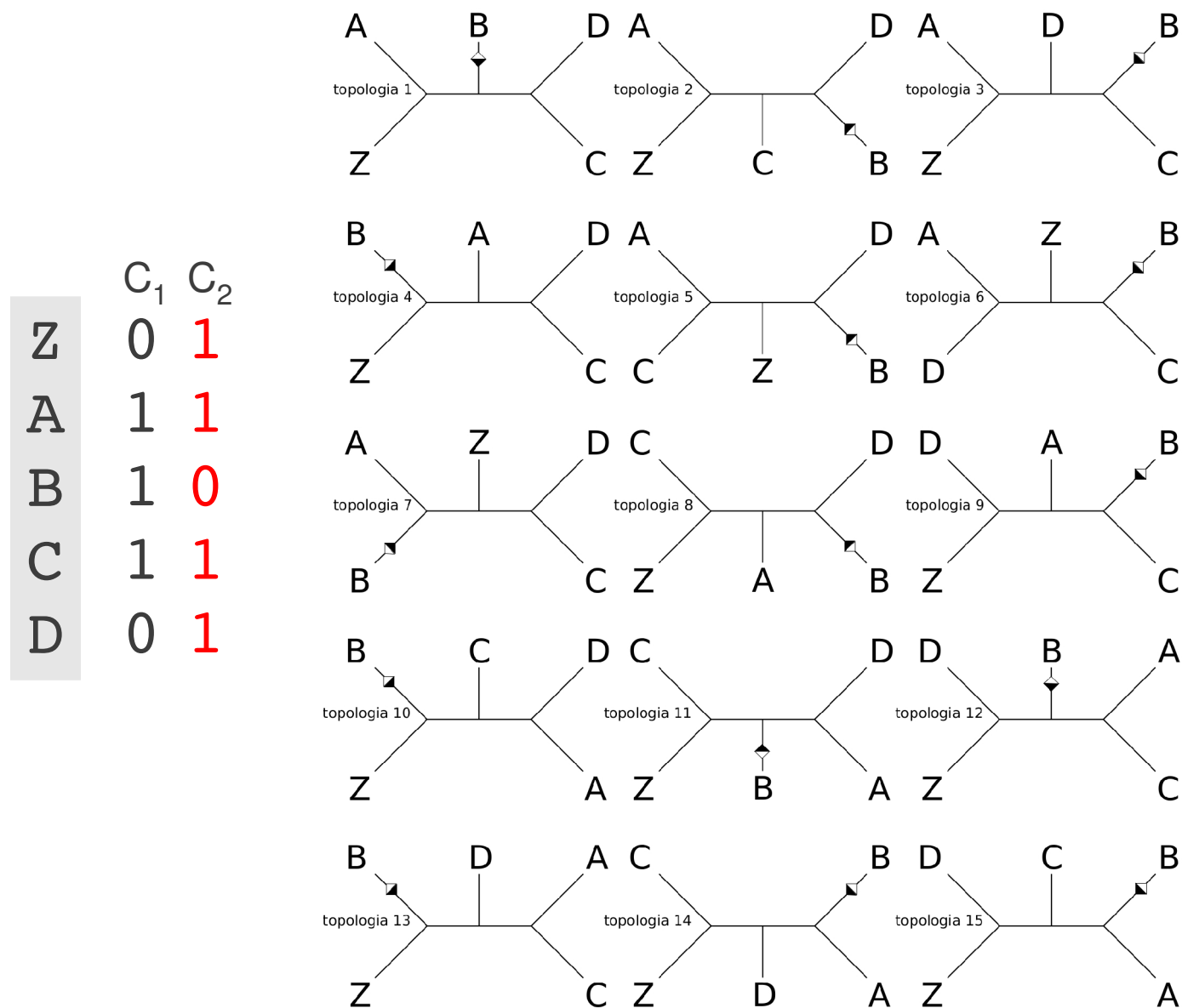

Uma transformação em todos os diagramas.

Caráter não-informativo!

Lógica da inferência filogenética

Avaliação e critério de seleção: soluções possíveis

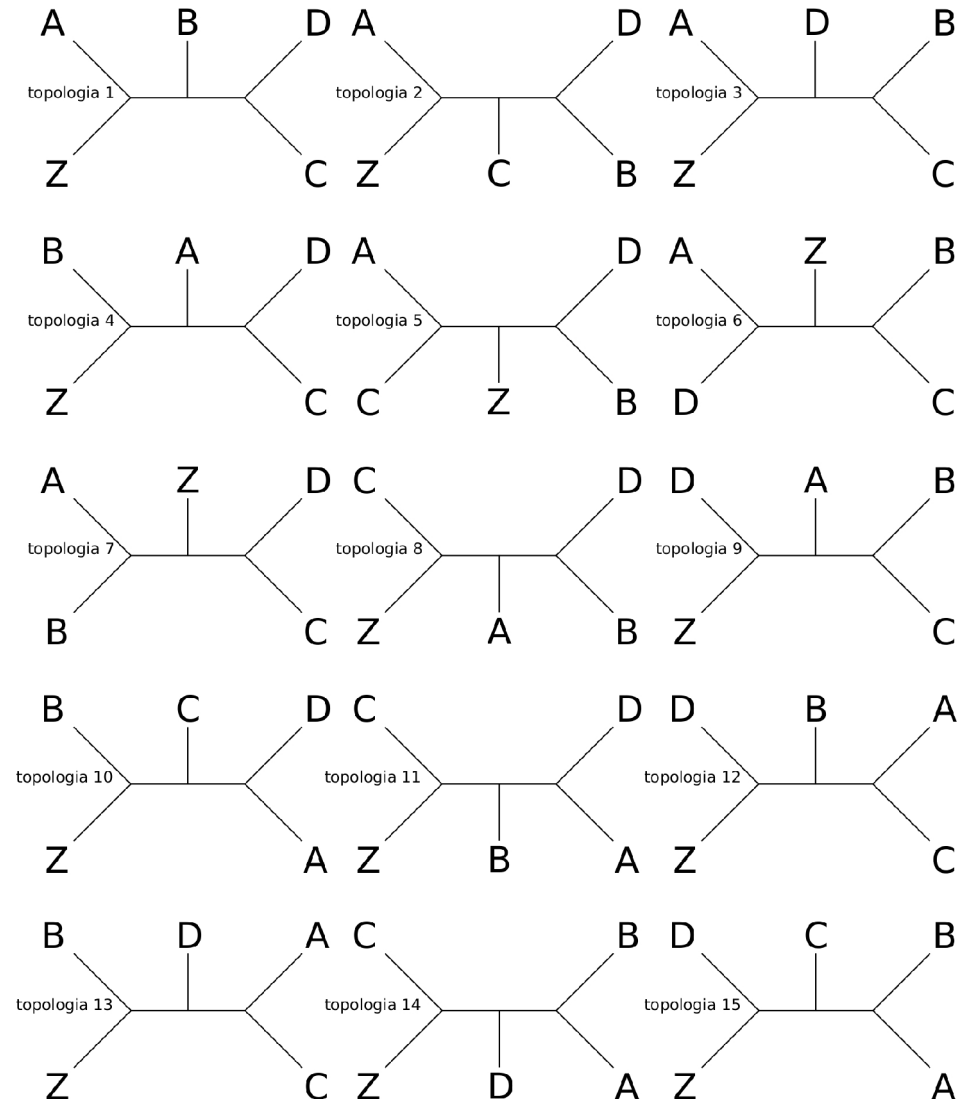
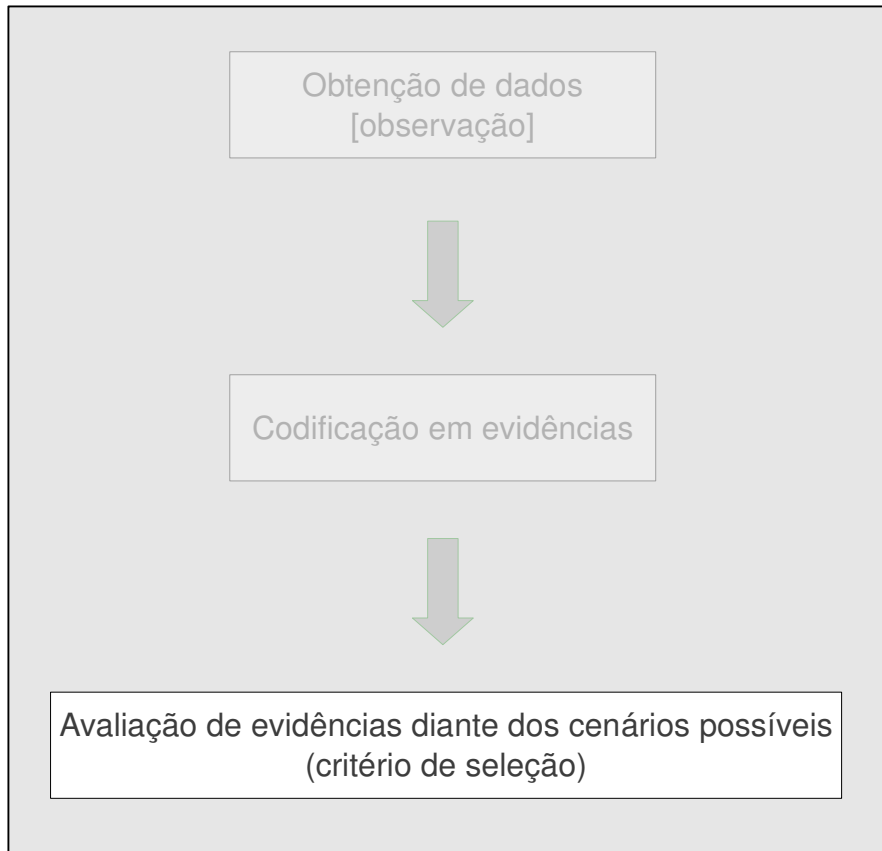

Lógica da inferência filogenética: critério de seleção

Cladística:

Otimização: refere-se a seleção do melhor elemento de um conjunto disponível de alternativas.

	C ₁	C ₂	C ₃	C ₄	C ₅	C ₆	C ₇	C ₈	C ₉	C ₁₀	C ₁₁	C ₁₂
Z	0	1	0	0	0	0	0	0	0	0	0	0
A	1	1	1	1	0	0	1	0	0	0	0	1
B	1	0	1	1	0	1	0	0	0	0	0	1
C	1	1	2	1	1	0	0	1	1	1	1	0
D	0	1	1	1	1	0	0	0	0	1	1	0

Topologia	Top. 1	Top. 2	Top. 3	Top. 4	Top. 5
Tranformações	15	15	14	18	18
Topologia	Top. 6	Top. 7	Top. 8	Top. 9	Top. 10
Tranformações	18	18	18	18	17
Topologia	Top. 11	Top. 12	Top. 13	Top. 14	Top. 15
Tranformações	18	18	17	17	16

Diferentes topologias podem gerar otimizações distintas.

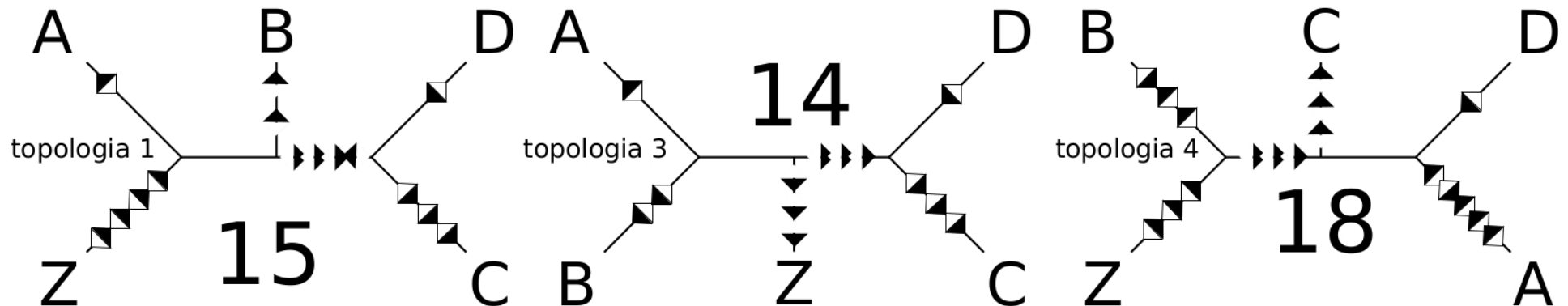

Lógica da inferência filogenética: critério de seleção

Cladística:

Otimização: refere-se a seleção do melhor elemento de um conjunto disponível de alternativas.

Diferentes topologias podem gerar otimizações distintas.

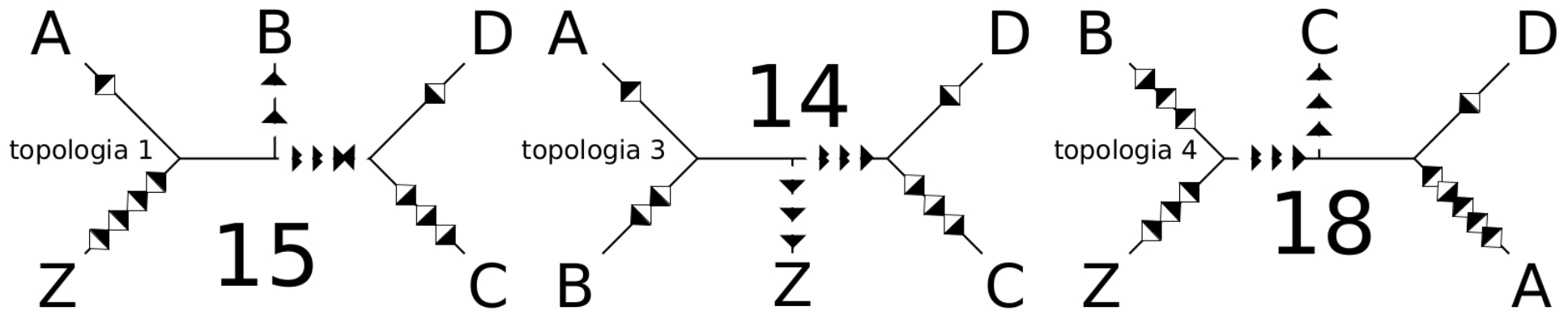

Menor distância patrística = f (

sp.X	1	3	2	2	1	3	0	1	2	3
sp.A	3	2	2	0	2	3	0	0	2	3
sp.B	1	1	3	0	2	1	0	0	2	3
sp.C	1	1	3	2	0	3	3	2	1	0

;



)

A **distância patrística** é a soma dos comprimentos de ramos em uma topologia.

Lógica da inferência filogenética: critério de seleção

Menor distância patrística = f (

sp.X	1	3	2	2	1	3	0	1	2	3
sp.A	3	2	0	2	3	0	0	2	3	
sp.B	1	1	3	0	2	1	0	0	2	3
sp.C	1	1	3	2	0	3	3	2	1	0

topologia 1

)

Justificativa para Parcimônia:

Prodedimento de inferência \neq modelo de evolução



“Systematic analysis 'must be done under the rules of parsimony, not because nature is parsimonious, but because only parsimonious hypotheses can be defended by the investigator without resorting to authoritarianism or apriorism.”

(Wiley, 1975 in Wheeler 2012)

Lógica da inferência filogenética: critério de seleção

Cladística:

Justificativa para Parcimônia:



Kluge (2005): descendência com modificação como modelo simplificado de evolução biológica: *“a minimal evolutionary assumption that offspring resemble their parents more than non-parents, but not exactly.”* (Wheeler, 2012)

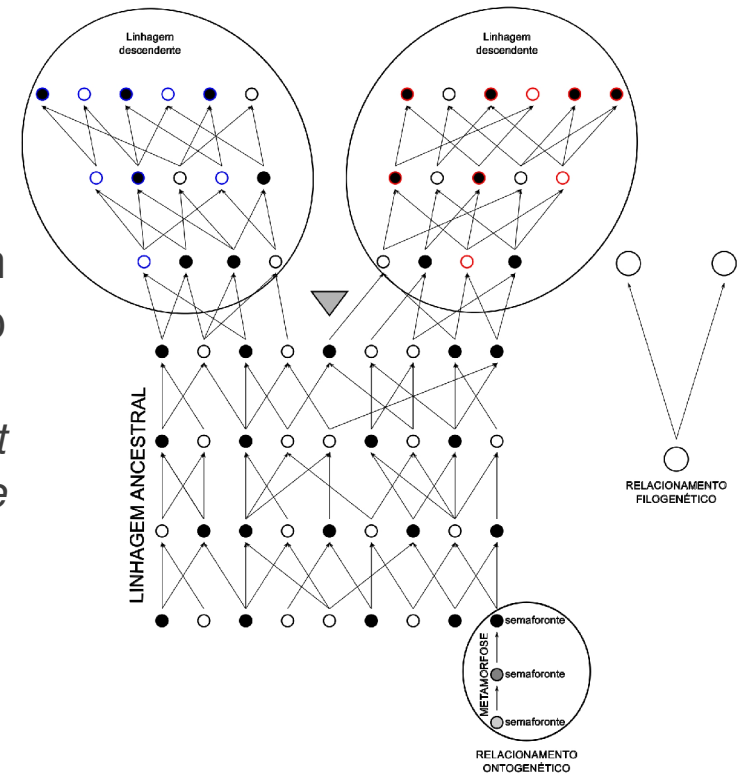

Qual desses cenários seria favorecido pelo critério de otimização?

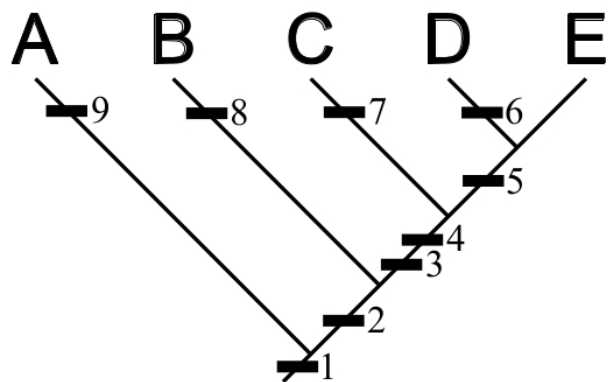

9 transformações

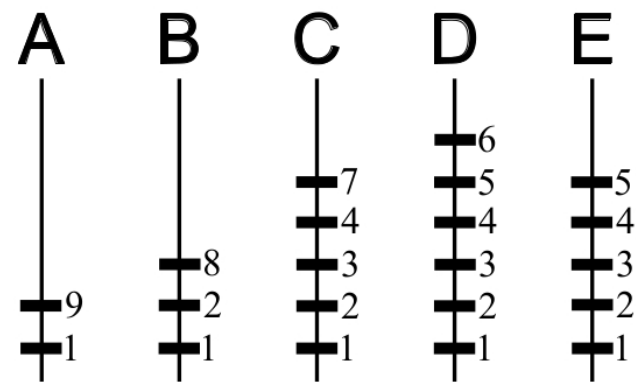

21 transformações

Lógica da inferência filogenética: critério de seleção

Cladística:

Justificativa para Parcimônia:



Kluge (2005): descendência com modificação como modelo simplificado de evolução biológica:

“a minimal evolutionary assumption that offspring resemble their parents more than non-parents, but not exactly.”

(Wheeler, 2012)

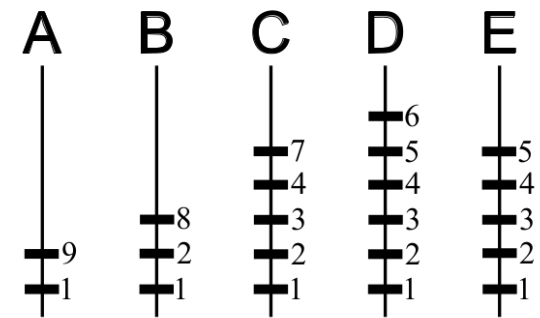
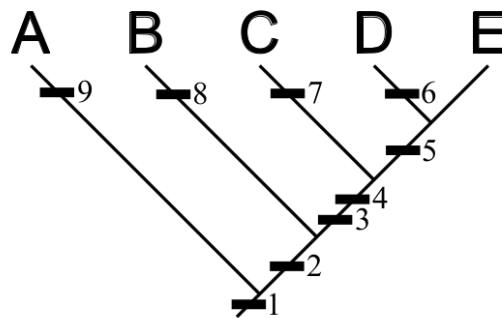

DESCENDÊNCIA COM MODIFICAÇÃO

H_0

H_1

CRITÉRIO DE PARCIMÔNIA

H_0

H_1

Conceitos fundamentais desta aula:

Cladística:

Evidência de relação de parentesco

Caráter = Série de transformação

Séries binárias e multi-estados

Estados de caráter

Parcimônia

Distância patrística

Otimização

Conteúdo informativo de caracteres

Justificativa para adoção do critério