

## ***Conceitos fundamentais da aula passada:***

*Essencialismo, Tipologismo e Fixismo*

*Homologia vs. não homologia (analogia/paralogia)*

*Seleção Natural: variabilidade, pressão seletiva e herança*

*Nova síntese e Sistemática Evolutiva (Gradismo)*

*Grupos monofiléticos, Zonas adaptativas e Grados*

# Desenvolvimento epistemológico da Sistemática

Aristóteles – 384-322 A.C.

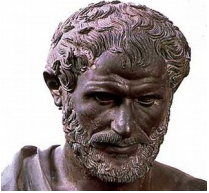

Darwin – 1809-1882



Período essencialista

384 a.C.

Carolus Linnaeus  
1707-1778



Buffon  
1707-1788



Lamarck  
1744 -1829



St-Hilair  
1772 -1844



Cuvier  
1769 -1832



Mundo dinâmico

Resistência e Nova Síntese

Sistemática Evolutiva

1859

1936 - 1947

1960's

Ernest Mayr  
1904 - 2005

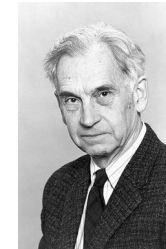

G.G. Simpson  
1902 - 1984



Theodosius Dobzhansky  
1900 -1975



# *Sistemática Evolutiva ou Taxonomia Evolutiva ou ainda Gradismo*

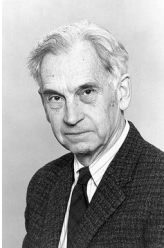

Ernest Mayr  
1904 - 2005

Simpson (1961) e Mayr (1969) aproximação dos estudos em Evolução, Genética e Paleontologia.



G.G. Simpson  
1902 - 1984

Genealogia por si só não era suficiente para criar classificações (sistema de referência).

Sistemática deve incluir informações sobre: ancestrais, processos e graus de mudanças evolutivas além de genealogias.

**Grado** → nível evolutivo: requer o julgamento sobre a importância de determinados caracteres

**Ponderação de informação** → narrativa histórica proposta: subjetiva e autoritária

**Filogenias** → um dos elementos da classificação: uma filogenia pode gerar várias classificações



Theodosius Dobzhansky  
1900 -1975

*“Even if we had perfect understanding of phylogeny, it would be possible to convert it into many different classifications.”*

(Mayr, 1969)

# Métodos empíricos e dedutivos

Ausência de métodos → ausência de replicação de resultados

Nova Síntese:

1. Prevalência de métodos indutivos de classificação: princípios pré-estabelecidos

Alguns caracteres são considerados “taxonomicamente mais importantes” e essenciais para a classificação



Arthur J. Cain (1921-1999)

Cain (1956:146): *“nós podemos apenas proceder empiricamente, simplesmente encontrando os subconjuntos existentes e quais são seus atributos, e não deduzi-los de princípios conhecidos e axiomas”.*

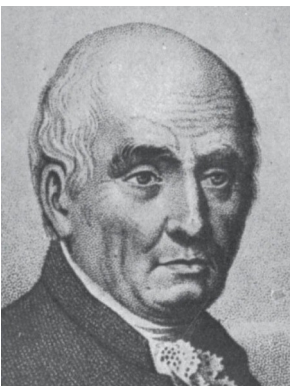

Michael Adanson (1727-1806)

***“La Física verdadera de las plantas es por lo tanto aquella que considera las relaciones de todas sus partes y cualidades, sin excepción de alguna; ella junta las plantas en familias naturales invariables, basadas en todas las relaciones posibles; facilita el estudio de la botánica al presentar el conocimiento desde el punto de vista más geral, sin limitarlo. Esta es la idea que debe tenerse del método natural; no hay otra y no puede haver otra, porque este método toma en consideración todos los aspectos en los cuales se puede poner atención.”***

(Adanson, 1763:clv-clviii – Familles de Plantes; em Papavero e Llorente-Bousquets [1994, vol. IV])

# Métodos empíricos e dedutivos

## Caminalculidae: Integral 2019

Grupo	Gênero	Espécies
Nicole Soluri, Sabrina Kaori & Lara Pacheco	1	[13,14][28]
Nicole Soluri, Sabrina Kaori & Lara Pacheco	2	[19][20]
Nicole Soluri, Sabrina Kaori & Lara Pacheco	3	[1,16][24]
Nicole Soluri, Sabrina Kaori & Lara Pacheco	4	[2,12][22]
Nicole Soluri, Sabrina Kaori & Lara Pacheco	5	[3,4]
Nicole Soluri, Sabrina Kaori & Lara Pacheco	6	[9]
Jonas, Mantovani, Teresa Filipo & Vitoria Spilock	1	[2][12]
Jonas, Mantovani, Teresa Filipo & Vitoria Spilock	2	[19][20]
Jonas, Mantovani, Teresa Filipo & Vitoria Spilock	3	[1,16,24][9]
Jonas, Mantovani, Teresa Filipo & Vitoria Spilock	4	[13,14][28]
Jonas, Mantovani, Teresa Filipo & Vitoria Spilock	5	[3][4]
Gabriela Peres, Juliana Bichler & Lucas C. Amaral	1	[1,16][24]
Gabriela Peres, Juliana Bichler & Lucas C. Amaral	2	[13,14][28]
Gabriela Peres, Juliana Bichler & Lucas C. Amaral	3	[2,12][22]
Gabriela Peres, Juliana Bichler & Lucas C. Amaral	4	[3][4]
Gabriela Peres, Juliana Bichler & Lucas C. Amaral	5	[19][20]
Carlo Toledo, Guilherme Yudi & Vício Guerra	1	[1,16][24]
Carlo Toledo, Guilherme Yudi & Vício Guerra	2	[19][20]
Carlo Toledo, Guilherme Yudi & Vício Guerra	3	[13,14][28]
Carlo Toledo, Guilherme Yudi & Vício Guerra	4	[2,4][3,12][22]
Carlo Toledo, Guilherme Yudi & Vício Guerra	5	[12]
Marina L. Tellers	1	[1,16][24]
Marina L. Tellers	2	[13,14][28]
Marina L. Tellers	3	[19][20]
Marina L. Tellers	4	[3][4][9]
Marina L. Tellers	5	[2][12][22]
Mariana C. Santos, Fernanda A.F. Damasio, Gabriela Matias & Julia R. Chonso	1	[9][13,14,28]
Mariana C. Santos, Fernanda A.F. Damasio, Gabriela Matias & Julia R. Chonso	2	[19][20]
Mariana C. Santos, Fernanda A.F. Damasio, Gabriela Matias & Julia R. Chonso	3	[1,16][24]
Mariana C. Santos, Fernanda A.F. Damasio, Gabriela Matias & Julia R. Chonso	4	[2,12,22][3,4]
Autores Anônimos I	1	[2,12,22][3,4]
Autores Anônimos I	2	[1,16][9][24]
Autores Anônimos I	3	[19][20]
Autores Anônimos I	4	[13,14][28]
Autores Anônimos II	1	[19][20]
Autores Anônimos II	2	[1,16][24]
Autores Anônimos II	3	[13,14][28]
Autores Anônimos II	4	[2,12][3,4][9][22]
Gustavo Chagas, Amarylis Lins & Joanna M. Batista	1	[19][20]
Gustavo Chagas, Amarylis Lins & Joanna M. Batista	2	[2,3,4,12,22][9][13,14,28]
Gustavo Chagas, Amarylis Lins & Joanna M. Batista	3	[1,16][24]
Autores Anônimos III	1	[1,16][24]
Autores Anônimos III	2	[2][12][22]
Autores Anônimos III	3	[3][4]
Autores Anônimos III	4	[13,14][28]
Autores Anônimos III	5	[9]
Autores Anônimos III	6	[19][20]
Larissa Correia, Marco Tramontano & Thiago Medeiros	1	[1][16][24]
Larissa Correia, Marco Tramontano & Thiago Medeiros	2	[2,4][3,12][22]
Larissa Correia, Marco Tramontano & Thiago Medeiros	3	[9][13,14][28]
Larissa Correia, Marco Tramontano & Thiago Medeiros	4	[19][20]
Paola Maria & Isabela Zogbi	1	[13,14][28]
Paola Maria & Isabela Zogbi	2	[1,16][24]
Paola Maria & Isabela Zogbi	3	[2,12][22]
Paola Maria & Isabela Zogbi	4	[3][4][9]
Paola Maria & Isabela Zogbi	5	[19][20]
Caio Penna & Nayara Moreira	1	[13,14][28]
Caio Penna & Nayara Moreira	2	[3,4][9]
Caio Penna & Nayara Moreira	3	[2,12][22]
Caio Penna & Nayara Moreira	4	[1,16][24]
Caio Penna & Nayara Moreira	5	[19][20]

## Dendrogramacea: Noturno 2019

Grupo	Gênero	Espécies
Amanda L. Braga & Júlio Pozzi	1	[1,2,9,10][3,15][4]
Amanda L. Braga & Júlio Pozzi	2	[5,6,12][7,11,16][8][13,14]
Amanda L. Braga & Júlio Pozzi	3	[17][18]
Catarina Molssás & Rebecca N.I. de Oliveira	1	[3,4][15,17,18]
Catarina Molssás & Rebecca N.I. de Oliveira	2	[5,6,12][7,8,11,16][13,14]
Catarina Molssás & Rebecca N.I. de Oliveira	3	[1][2,9,10]
Marvin Afonso & Walter Mota	1	[5,12][6][7,11,16][13,14]
Marvin Afonso & Walter Mota	2	[15,17,18]
Marvin Afonso & Walter Mota	3	[2,9,10][3,4]
Marvin Afonso & Walter Mota	4	[1]
Marvin Afonso & Walter Mota	5	[8]
Vinicius Oliveira & Kayque Lucas	1	[5][6][7,11,16][8][13,14]
Vinicius Oliveira & Kayque Lucas	2	[1][2,9,10][3,4][15][17][18]
Felipe S. Lauria & Marínan C. Bossan	1	[1][2][3][4][9,10]
Felipe S. Lauria & Marínan C. Bossan	2	[5,12][6][7,11][8][13,14,16]
Felipe S. Lauria & Marínan C. Bossan	3	[15][17]
Natalia C. Escarlate	1	[6,12][3,4,10,13,14,15,17,18]
Natalia C. Escarlate	2	[1][2,9][5,7,11,16]
Guilherme Romão & Guilherme Correa	1	[1,2,3,5,7,8,9,10,11,12,13,14,16][3,15,17,18]
Guilherme Romão & Guilherme Correa	2	[4]
Guilherme Romão & Guilherme Correa	3	[6]
Hilton P. Camargo Jr., Isabela C.N. Rocha & Maria Cristina C. P. Barbosa	1	[2,9,10][3][4]
Hilton P. Camargo Jr., Isabela C.N. Rocha & Maria Cristina C. P. Barbosa	2	[1]
Hilton P. Camargo Jr., Isabela C.N. Rocha & Maria Cristina C. P. Barbosa	3	[5,6,12][7,11,16][13,14]
Hilton P. Camargo Jr., Isabela C.N. Rocha & Maria Cristina C. P. Barbosa	4	[8]
Hilton P. Camargo Jr., Isabela C.N. Rocha & Maria Cristina C. P. Barbosa	5	[15][17][18]
Ana Claudia Colhx, Gabriel Santi & Victor Marina	1	[3,4][9,10]
Ana Claudia Colhx, Gabriel Santi & Victor Marina	2	[1][2]
Ana Claudia Colhx, Gabriel Santi & Victor Marina	3	[7,11][8,16]
Ana Claudia Colhx, Gabriel Santi & Victor Marina	4	[13][14]
Ana Claudia Colhx, Gabriel Santi & Victor Marina	5	[15][17][18]
Ana Claudia Colhx, Gabriel Santi & Victor Marina	6	[5,12][6]
Renan C. Salvador & Mikael Jorge	1	[13][14]
Renan C. Salvador & Mikael Jorge	2	[5,12][6]
Renan C. Salvador & Mikael Jorge	3	[1,2,4,9,10][3,15,17,18][7,11,16][8]
Kamila L. Mariano, Danielle R. Costa & Brunos R Moller	1	[13][14]
Kamila L. Mariano, Danielle R. Costa & Brunos R Moller	2	[3][4][15][17][18]
Kamila L. Mariano, Danielle R. Costa & Brunos R Moller	3	[7][11][16]
Kamila L. Mariano, Danielle R. Costa & Brunos R Moller	4	[5][6][12]
Kamila L. Mariano, Danielle R. Costa & Brunos R Moller	5	[1][2][9][10]
Kamila L. Mariano, Danielle R. Costa & Brunos R Moller	6	[8]
Anônimo I	1	[2][9][10]
Anônimo I	2	[3][4]
Anônimo I	3	[7][11][16]
Anônimo I	4	[13][14]
Anônimo I	5	[5][6][12]
Anônimo I	6	[15][17][18]
Anônimo I	7	[8]
Fernando A. Silveiro & Marcelo B. Monhoz	1	[1][2,9,10]
Fernando A. Silveiro & Marcelo B. Monhoz	2	[3][15][17,18]
Fernando A. Silveiro & Marcelo B. Monhoz	3	[7,11][16]
Fernando A. Silveiro & Marcelo B. Monhoz	4	[13,14]
Fernando A. Silveiro & Marcelo B. Monhoz	5	[5,12][6]
Fernando A. Silveiro & Marcelo B. Monhoz	6	[8]

# *Métodos empíricos e dedutivos*

→ Variação no número de espécies e gêneros por grupo:

## Caminalculidae: Integral 2019

Grupos (n=13)	N. Gêneros	N. espécies
Nicole Soluri, Sabrina Kaori & Lara Pacheco	6	10
Jonas, Mantovani, Teresa Filipo & Vitoria Spilock	5	10
Gabriela Peres, Juliana Bichler & Lucas C. Amaral	5	10
Carlo Toledo, Guilherme Yudi & Vício Guerra	5	10
Marina L. Tellers	5	12
Mariana C. Santos, Fernanda A.F. Damasio, Gabriela Matias & Julia R. Chonso	4	8
Autores Anônimos I	4	9
Autores Anônimos II	4	10
Gustavo Chagas, Amarylis Lins & Joanna M. Batista	3	7
Autores Anônimos III	6	12
Larissa Correia, Marco Tramontano & Thiago Medeiros	4	11
Paola Maria & Isabela Zogbi	5	11
Caio Penna & Nayara Moreira	5	10

## Dendrogramacea: Noturno 2019

Grupos (n=13)	N. Gêneros	N. espécies
Amanda L. Braga & Júlio Pozzi	3	9
Catarina Molssás & Rebecca N.I. de Oliveira	3	7
Marvin Afonso & Walter Mota	5	9
Vínicus Oliveira & Kayque Lucas	2	11
Felipe S. Lauria & Marínan C. Bossan	3	12
Natalia C. Escarlata	2	5
Guilherme Romão & Guilherme Correa	3	4
Hilton P. Camargo Jr., Isabela C.N. Rocha & Maria Cristina C. P. Barbosa	5	11
Ana Claudia Colhx, Gabriel Santi & Victor Marina	6	13
Renan C. Salvador & Mikael Jorge	2	8
Kamila L. Mariano, Danielle R. Costa & Brunos R Moller	6	18
Anônimo I	7	17
Fernando A. Silveiro & Marcelo B. Monhoz	6	11

# Métodos empíricos e dedutivos

→ Variação nas propostas de gêneros por grupos:

## Caminalculidae: Integral 2019

Gêneros (n=22)	N. Grupos (n=13)
[19][20]	13
[1,16][24]	10
[13,14][28]	10
[2,12][22]	4
[3][4]	3
[2,12,22][3,4]	2
[2,4][3,12][22]	2
[3][4][9]	2
[9]	2
[1,16,24][9]	1
[1][16][24]	1
[1,16][9][24]	1
[12]	1
[2][12][22]	1
[2][12][22]	1
[2,12][3,4][9][22]	1
[2][12]	1
[2,3,4,12,22][9][13,14,28]	1
[3,4][9]	1
[3,4]	1
[9][13,14][28]	1
[9][13,14,28]	1

## Dendrogramacea: Noturno 2019

Gêneros (n=39)	N. Grupos (n=13)
[8]	5
[13][14]	4
[5,12][6]	3
[15][17][18]	3
[7][11][16]	2
[5][6][12]	2
[1][2,9,10]	2
[1]	2
[7,11][8,16]	1
[7,11][16]	1
[6]	1
[6,12][3,4,10,13,14,15,17,18]	1
[5][6][7,11,16][8][13,14]	1
[5,6,12][7,8,11,16][13,14]	1
[5,6,12][7,11,16][8][13,14]	1
[5,6,12][7,11,16][13,14]	1
[5,12][6][7,11][8][13,14,16]	1
[5,12][6][7,11,16][13,14]	1
[4]	1
[3][4][15][17][18]	1
[3][4]	1
[3][15][17,18]	1
[3,4][9,10]	1
[3,4][15,17,18]	1
[2][9][10]	1
[2,9,10][3][4]	1
[2,9,10][3,4]	1
[17][18]	1
[15][17]	1
[15,17,18]	1
[13,14]	1
[1][2][9][10]	1
[1][2][3][4][9,10]	1
[1][2]	1
[1][2,9][5,7,11,16]	1
[1][2,9,10][3,4][15][17][18]	1
[1,2,9,10][3,15][4]	1
[1,2,4,9,10][3,15,17,18][7,11,16][8]	1
[1,2,3,5,7,8,9,10,11,12,13,14,16][3,	1

# *Métodos empíricos e dedutivos*

→ Variação nas propostas de espécies por grupos:

## Caminalculidae: Integral 2019

Conceitos de espécies (n=22)	N. Grupos (n=13)
[19]	13
[20]	13
[24]	12
[13,14]	11
[28]	11
[1,16]	10
[9]	10
[22]	9
[2,12]	5
[3,4]	5
[3]	5
[4]	5
[12]	4
[2]	3
[13,14,28]	2
[2,12,22]	2
[2,4]	2
[3,12]	2
[1,16,24]	1
[16]	1
[1]	1
[2,3,4,12,22]	1

## Dendrogramacea: Noturno 2019

Conceitos de espécies (n=40)	N. Grupos (n=13)
[1]	9
[6]	9
[8]	9
[15]	7
[17]	7
[13,14]	6
[18]	6
[4]	6
[2,9,10]	5
[3]	5
[5,12]	5
[7,11,16]	5
[13]	4
[14]	4
[2]	4
[3,4]	4
[16]	3
[5,6,12]	3
[5]	3
[7,11]	3
[9,10]	3
[11]	2
[12]	2
[15,17,18]	2
[3,15,17,18]	2
[7]	2
[10]	1
[1,2,3,5,7,8,9,10,11,12,13,14,16]	1
[1,2,4,9,10]	1
[1,2,9,10]	1
[13,14,16]	1
[17,18]	1
[2,9]	1
[3,15]	1
[3,4,10,13,14,15,17,18]	1
[5,7,11,16]	1
[6,12]	1
[7,8,11,16]	1
[8,16]	1
[9]	1



## *Problemas associados à ausência de métodos:*

- 1. Inabilidade de avaliar objetivamente hipóteses.**
- 2. Prevalência de autoritarismo científico.**
- 3. Ausência de reprodutibilidade.**

# Homologias vs. não homologias



Posterior a Darwin (1859), aqueles similaridades que indicam ancestral comum (homologias) tornaram-se mais importantes em classificação que aquelas similaridades que não decorrem de ancestrais comuns.



Lankester (1870a,b): conceito inicial de homologia

**'Homogenia'**: similaridade decorrente de ancestrais comuns.

**'Homoplasia'**: similaridade decorrente de função similar e causalidade.

Sir Edwin Ray Lankester  
1847 — 1929

Nixon & Carpenter (2012): conceito mais recente de homologia

**'Homologia'**: similaridade decorrente de ancestrais comuns.

**'Homoplasia'**: similaridade não-homóloga.

**Lankester**, E.R., 1870a. On the use of the term homology in modern zoology, and the distinction between homogenetic and homoplastic agreements. Ann. Mag. Nat. Hist. ser. 4. 6, 34–43.

**Lankester**, E.R., 1870b. On the use of the term "homology". Ann. Mag. Nat. Hist. ser. 4. 6, 342.

**Nixon & Carpenter** 2012. On homology. Cladistics 28(2)160–169.

# *Similaridade e ancestralidade*

## **Como fazer a distinção entre esses dois tipos de similaridades?**



Arthur J. Cain (1921-1999)

Cain sugere que:

1. A questão não pode ser respondida com confiança.
2. Semelhanças gerais deveriam ser consideradas (como Adanson havia proposto inicialmente).

Cain & Harrison (1958:86, 96):

1. Estimativas da verdadeira afinidade no sentido filogenético são logicamente e posterior a afinidade por semelhança geral:

Similaridade → relações ancestrais

2. inclusão ou exclusão de caracteres uma vez que um padrão geral é observado ou na presença de dados auxiliares (e.g., idade geológica e distribuição geográfica, função ecológicas, genética e variações intra-específicas).

*A profecia:*

**Cain (1959:241):**

*"Eu acho que nós estamos para ver uma considerável revisão em toda a teoria taxonômica, especialmente em relação à filogenia a classificações naturais, a clara separação do peso filogenético do reconhecimento da covariação de caracteres, e o desenvolvimento de métodos para fazer comparações, seja filogenético ou natural, mais precisos."*

# O nascimento da Fenética (Taxonomia numérica)

Snow Museum of Natural History, Lawrence, Kansas – Década de 50.

Aristóteles – 384-322 A.C.

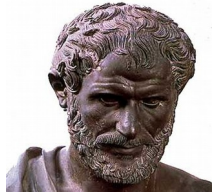

Darwin  
1809-1882

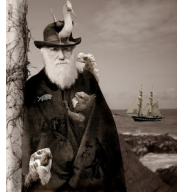

1859

Período essencialista

Mundo dinâmico

Resistência e Nova Síntese

Sistemática Evolutiva

1936 - 1947

1960's

Fenética

1970's

Carolus Linnaeus  
1707-1778



Buffon  
1707-1788



Lamarck  
1744 -1829



St-Hilair  
1772 -1844



Cuvier  
1769 -1832



Ernest Mayr  
1904 - 2005

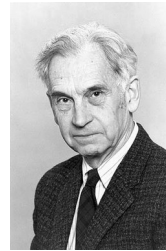

Paul Erlich

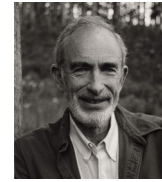

G.G. Simpson  
1902 - 1984

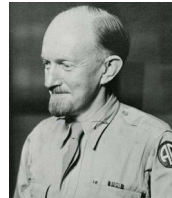

Theodosius Dobzhansky  
1900 -1975

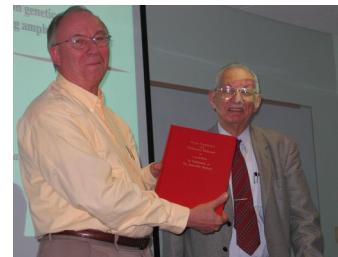

James Rohlf R. Sokal  
1926 -

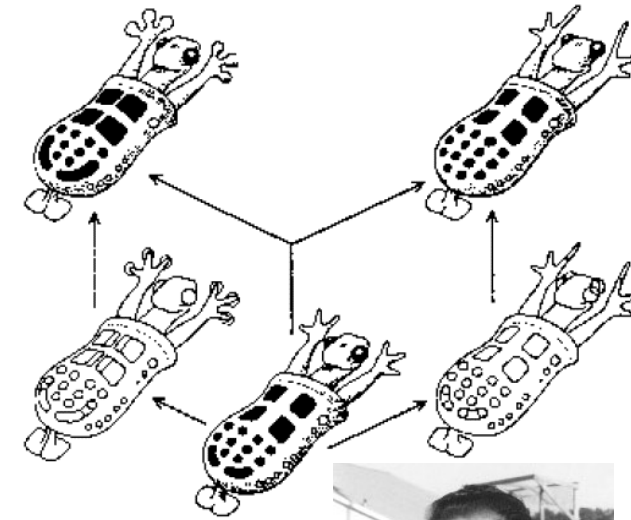

# O nascimento da Fenética

Robert Sokal – junta-se a Michener [entomologista] no SMNH em 1951.

Clyde Stroud, em Chicago, teria influenciado Sokal em aplicar técnicas quantitativas em fenômenos biológicos.

Sokal rejeita os métodos intuitivos em classificações taxonômicas. Para ele classificações deveriam ser elaboradas por métodos estatísticos explícitos.

Sokal e Michener notam que a mesma classificação não poderia mostrar ordem de ramificações encontradas em uma árvore filogenética e grau de similaridade ao mesmo tempo: estabelecem a ruptura entre padrões e processos em sistemática.



Michener em 1956



Sokal em 1964

## INTRODUCTION

The purpose of the study reported in this paper was to determine whether certain statistical procedures might aid persons interested in the relationships among organisms. The objectives of our study were to investigate numerous characters simultaneously in a considerable group of species; to quantify the relations shown among the species, using objective methods; and to indicate these relationships. The organisms selected as an example for use in this study are solitary bees in the family Megachilidae. This choice was made because one of us (C. D. M.) has made recent systematic studies of these insects, so that conclusions as to the relationships obtained by usual systematic procedures could be compared

with the results of the methods described below.

A major concern of the systematist, when he devises a classification, is to make one in accordance with probable phylogeny, but first he must assess the characters and determine relationships in a static or nonhistorical sense. Later he may decide on the most likely lines of descent. The greater part of this paper concerns the first step, determination of static relationships, although ideas as to phylogeny are, of course, included.

In the absence of data from fossils, and sometimes even when these are available, systematists often differ widely as to relationships among organisms. This is true even if problems raised by convergence and varying rates of evolution can be settled or temporarily ignored. It is easier to appreciate differences than similarities. Therefore, in most groups, the species are differentiated long before serious studies of relationships begin. A systematist who is interested in phylogeny, but lacks paleontological data, utilizes character correlations observed in the course of his study in determining relationships and delimiting the levels (genera, families, etc.) in the hierarchy of classification.

Each species has an enormous number of characters. The systematist normally tries to use as many as he can find, but is hampered in his study of character correlations by the limitations of the human mind. Also, he is necessarily subjective in his choice and weighting of characters. If he notes that certain characters vary erratically with respect to one another

## Weighting of Characters

Each species has an enormous number of characters. The systematist normally tries to use as many as he can find, but is hampered in his study of character correlations by the limitations of the human mind. Also, he is necessarily subjective in his choice and weighting of characters.

If he notes that certain characters vary erratically with respect to one another

<sup>1</sup>Contribution number 936 from the Department of Entomology, University of Kansas, Lawrence. Some of the work by one of the authors (C. D. M.) was done at the Universidade do Paraná, Curitiba, Brazil.

<sup>2</sup>We wish to acknowledge the constructive criticism received from the following individuals who kindly gave their time to read and comment upon our manuscript: Paul R. Ehrlich, University of Kansas; A. E. Emerson, University of Chicago; Warwick E. Kerr, Universidade de São Paulo; Ernst Mayr, Harvard University; G. G. Simpson, American Museum of Natural History; Peter C. Silvester-Bradley, University of Kansas and University of Sheffield; and Paulo E. Vanzolini, Departamento de Zoologia, Secretaria de Agricultura, São Paulo. These persons, however, are not responsible for the opinions which we have expressed.

The ideas presented herein were first tried out on informal groups, the "Biosystematists" and "Evolutionists," at the University of Kansas; we received worthwhile suggestions from various members of each group.

We wish also to acknowledge contributions from the University of Kansas General Research Fund for assistance.

# *O nascimento da Fenética*

A comunidade científica rejeita suas idéias pelos seguintes aspectos:

Uso de técnicas computacionais em taxonomia

Inexistência de pesos para caracteres “mais importantes”.

Paul Ehrlich (1961) faz as seguintes previsões:

Computadores seriam ferramentas fundamentais para taxônomos.

Pouca ênfase seria dada à nomenclatura

Monografias taxonômicas seriam substituídas por matrizes de dados.

# Princípios da fenética: similaridade e parentesco

Estimativas da “verdadeira” afinidade no sentido filogenético são “logicamente e historicamente posteriores às estimativas de similaridade global” (Cain & Harrison, 1958:86, 96). Conseqüentemente, similaridade global deve ser atribuída primeiro, antes de qualquer tentativa de inferir relações de ancestral/descendente.

Relações entre OTUs são expressas por fenogramas.

OTU – Operational Taxonomic Units.

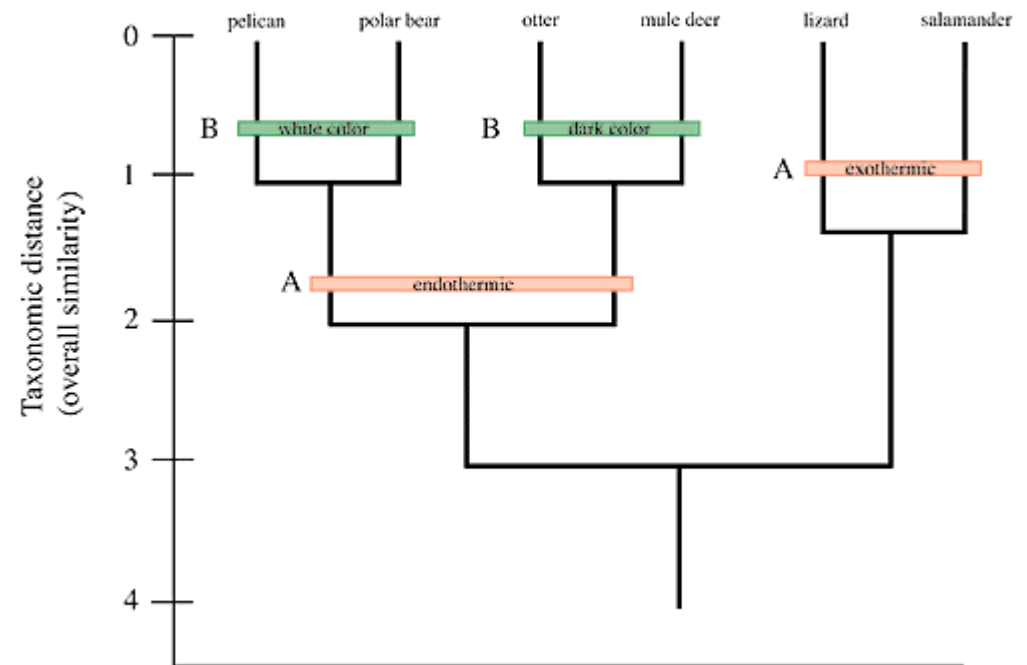
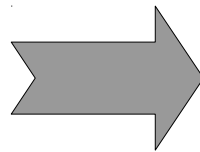

*"It should be remembered that while diagrams such as figure 1 may suggest phylogenies, in reality they only indicate static relationships."*

(Sokal & Michener, 1958:1437)



# *Lógica da inferência filogenética*

*“Operationally, systematics proceeds by gathering data (observations) from organisms and coding them into evidence to test competing phylogenetic scenarios”*

(Wheeler et al., 2006:7)

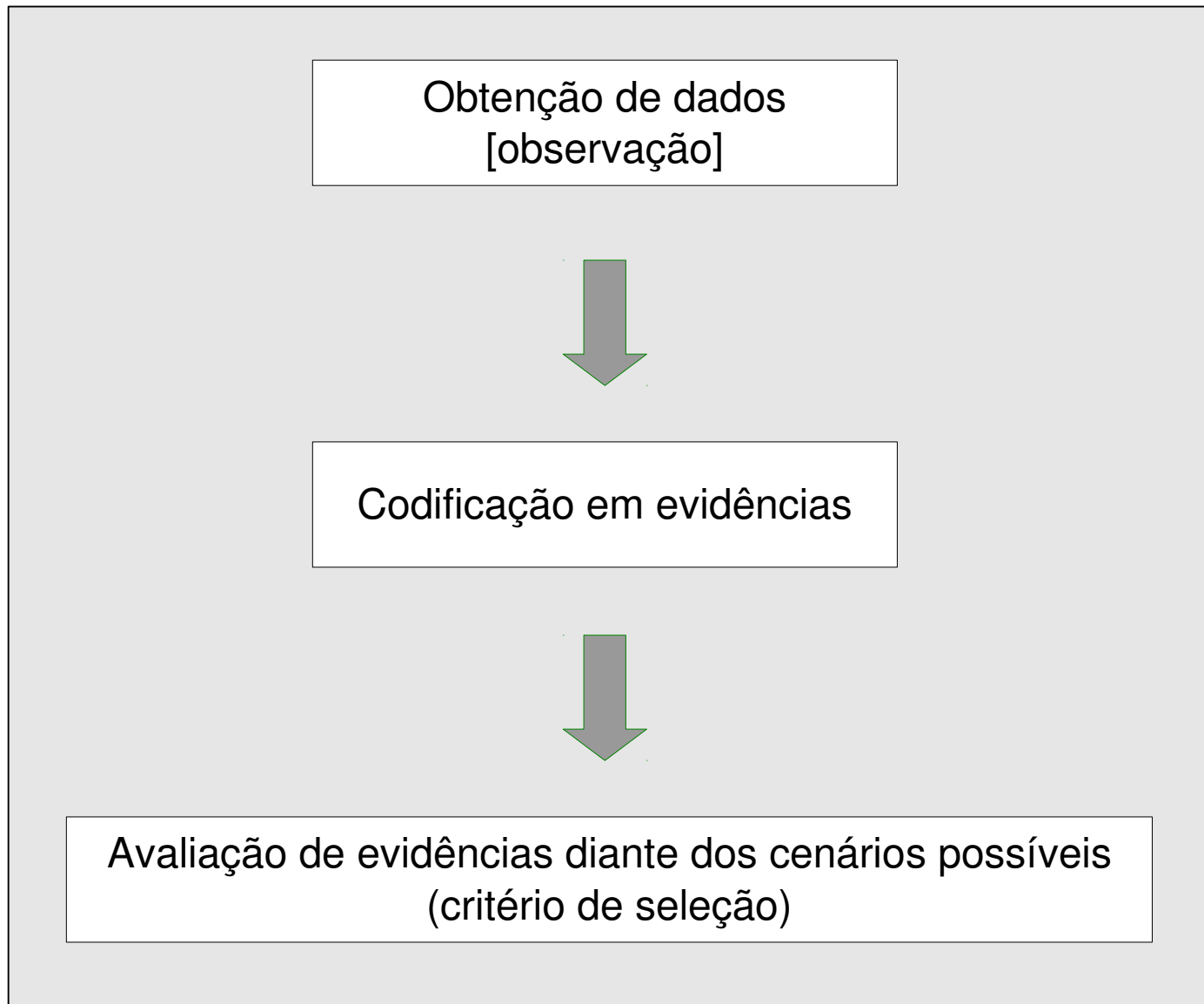

# *Lógica da inferência filogenética*

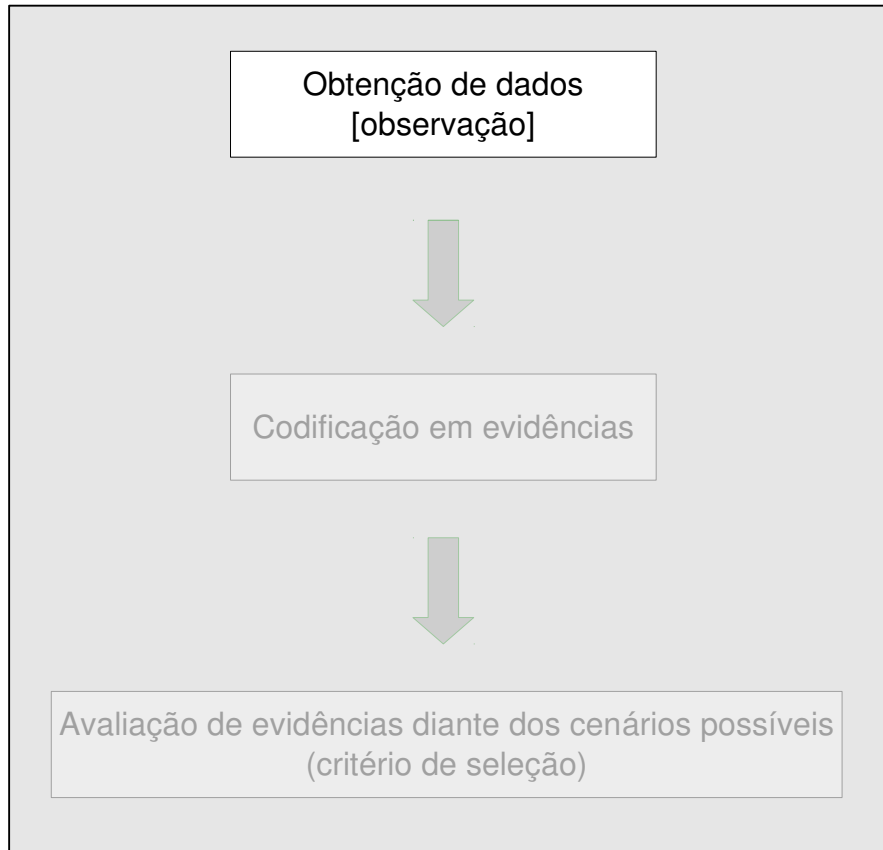

*“Em princípio, qualquer observação de atributos de organismos possuem o potencial de fornecer evidências de relação de parentesco. No entanto, as evidências mais objetivas são derivadas daqueles atributos que são hereditários e intrínsecos dos organismos porque eles refletem a continuidade biológica entre ancestral e descendente (Hennig, 1966)”* (Wheeler et al., 2006:7)

# Lógica da inferência filogenética

## Condições necessárias e suficientes de atributos

Popper (1934, 1959): "characters are theory-laden objects".

Observações organizadas e contextualizadas:

- relevância
- comparabilidade
- correspondência

Atributos intrínsecos:

- genotípicos
- fenotípicos

*"The semaphoront is defined as an individual in an ideally very small 'time-slice' or duration."*

[O semeforonte é definido como um indivíduo em uma fatia temporal idealizada ou duração muito curta.]

(Hennig, 1950: 9, 1966: 6)

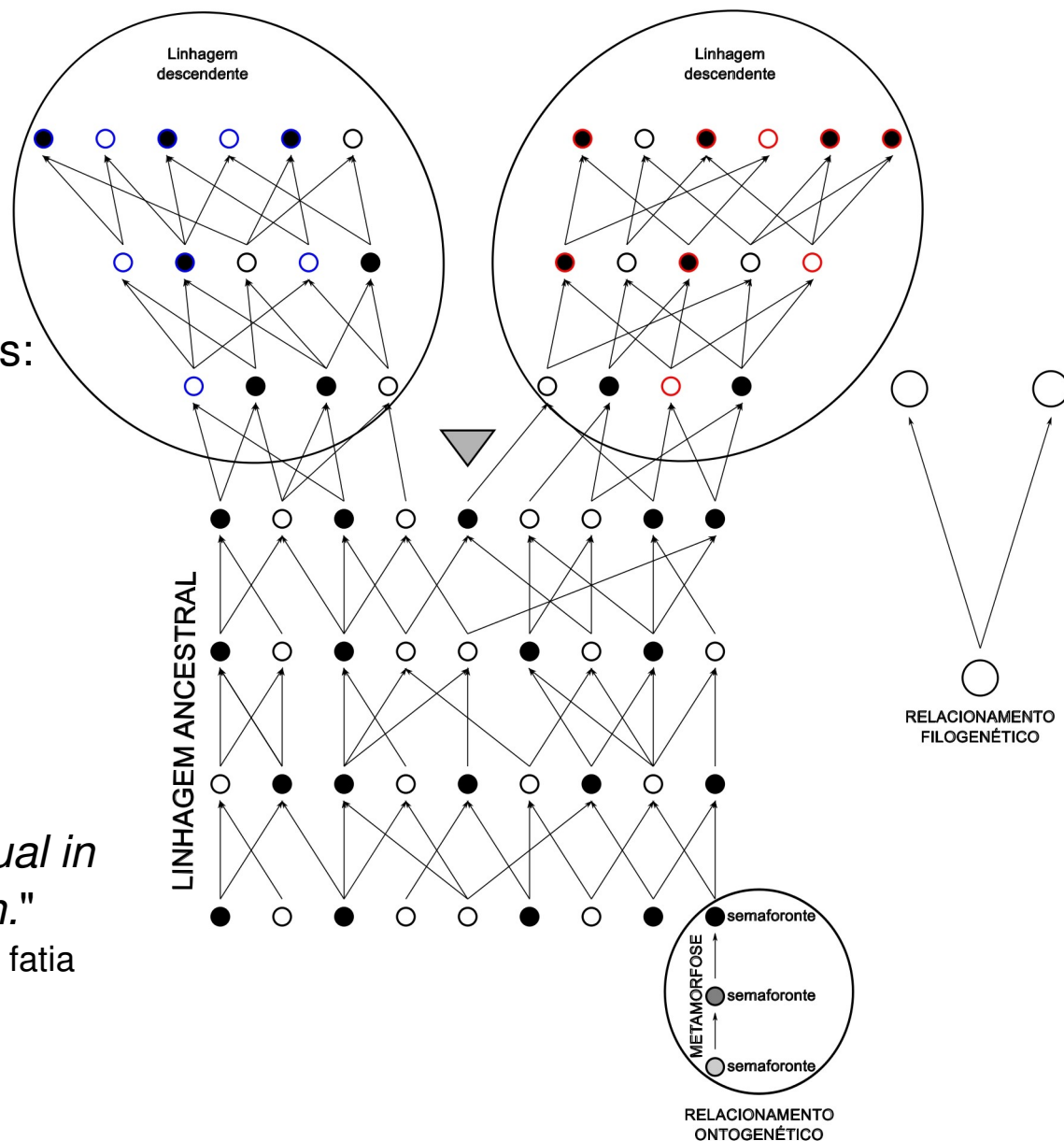

# Lógica da inferência filogenética

## Condições necessárias e suficientes de atributos

Primate mtDNA

Project of "Primate mtDNA" - Character Matrix "Character Matrix"

Taxon \ Character	1	2	3	4	5	6	7	8	9	10	11	12	13	14	15	16	17	18	19	20	21	22	23	24	25	26	27	28	29	30	31	32	33	34	
1 Homo sapiens	A	A	A	A	A	A	A	A	A	A	A	A	A	A	A	A	A	A	A	A	A	A	A	A	A	A	A	A	A	A	A	A	A	A	
2 Pan	A	A	G	C	T	T	C	A	C	C	G	G	C	G	C	A	G	T	C	A	T	T	C	C	T	C	A	T	A	A	T	C	G	C	C
3 Gorilla	A	A	G	C	T	T	C	A	C	C	G	G	C	G	C	A	G	T	C	A	T	T	C	C	T	C	A	T	A	A	T	C	G	C	C
4 Pongo	A	A	G	C	T	T	C	A	C	C	G	G	C	G	C	A	A	C	C	A	C	C	T	C	C	A	T	G	A	T	T	G	C	C	C
5 Hylobates	A	A	G	C	T	T	T	A	C	A	G	G	T	G	C	A	A	C	C	G	T	C	C	T	C	A	T	A	T	C	G	C	C	C	
6 Macaca fuscata	A	A	G	C	T	T	T	T	C	C	G	G	C	G	C	A	A	C	C	A	T	C	C	T	T	A	T	G	A	T	C	G	C	C	T
7 M. mulatta	A	A	G	C	T	T	T	T	C	C	G	G	C	G	C	A	A	C	C	A	T	C	C	T	T	A	T	G	A	T	C	G	C	T	
8 M. fascicularis	A	A	G	C	T	T	T	T	C	C	G	G	C	G	C	A	A	C	C	A	T	C	C	T	T	A	T	A	T	C	G	C	C	C	
9 M. sylvanus	A	A	G	C	T	T	T	T	C	C	G	G	T	G	C	A	A	C	C	A	T	C	C	T	T	A	T	A	T	C	G	C	C	C	
10 Saimiri sciureus	A	A	G	C	T	T	C	A	C	C	G	G	C	G	C	A	A	T	G	A	T	C	C	T	A	T	A	T	A	T	C	G	C	T	T
11 Tarsius syrichta	A	A	G	T	T	C	A	T	T	G	G	A	G	C	A	C	A	C	A	C	A	T	C	T	T	A	T	A	A	T	T	G	C	C	C
12 Lemur catta	A	A	G	C	T	T	C	A	T	A	G	G	A	G	C	A	C	A	A	T	T	C	T	A	A	T	A	A	T	C	G	C	A	A	A

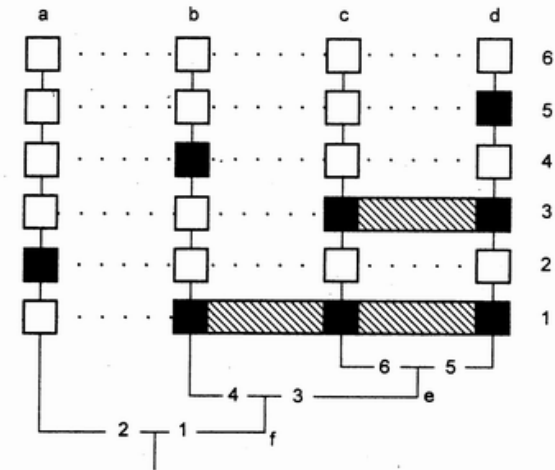

Bembidion.nex

Project of "Bembidion.nex" - Character Matrix "Bembidion"

Taxon \ Character	1	2	3	4	5	6	7	8	9	10	11	12					
1 balli	1	1	1	0	-	0	0	1&2	1	0	0	0	1	1	1	0	4
2 foveum	1	1	1	0	-	0	0	1&2	1	0	0&1	1	1	1	1	1	0
3 argenteolum	1	3	2&3	0&1	-	0	0	2	0	0	0	2	1	1	0	0	0
4 alaskense	1	3	2&3	0	-	0&1	0	2	0	0	1	0	1	1	0	1	0
5 *semenovi	1	2	2	0	-	0	0	2	0	0	0	3	1	1	0	0	0
6 stenoderum	1	3	3	0&2	0	0	0	1&2	0	0	0	2	1	1	1	0	0
7 carinula	1	3	0&1&2	0	-	0	0	2	1	0	0&1	1	1	1	1	0	0
8 velox	1	3	0&1&2	1	-	0	0	2	1	0	0	0	1	1	1	0	0
9 lapponicum	1	3	0&1&2&3	0&2	0	0	0	2	1	0	0&1	0	1	1	1	0	0
10 punctatostriatum	1	3	0&1&2	1	-	0	0	0	1	0	0	0	2	1	1	0	0
11 hesperium	1	2&3	3	0&2	0	0&1	0&1&2	1	0	0	0	0	1	1	1	0	0
12 lorquinii	1	3	3	1	-	0&1	0	0&1	0	0	0	0	1	1	1	0	0
13 zephyrum	1	3	3	2&3	0	0&1	0	2	1	0	1	0	1	1	1	0	0
14 l. levettei	1	3	3	3	0	1	0	2	1	0	0&1	0	1	1	1	0	0
15 l. carianum	1	3	3	3	0	1	0	2	1	0	0&1	0	1	1	1	0	0

Não há fonte de dados melhor que outra, mas elas diferem quando ao seu nível de generalidade (conteúdo informativo).

# Lógica da inferência filogenética

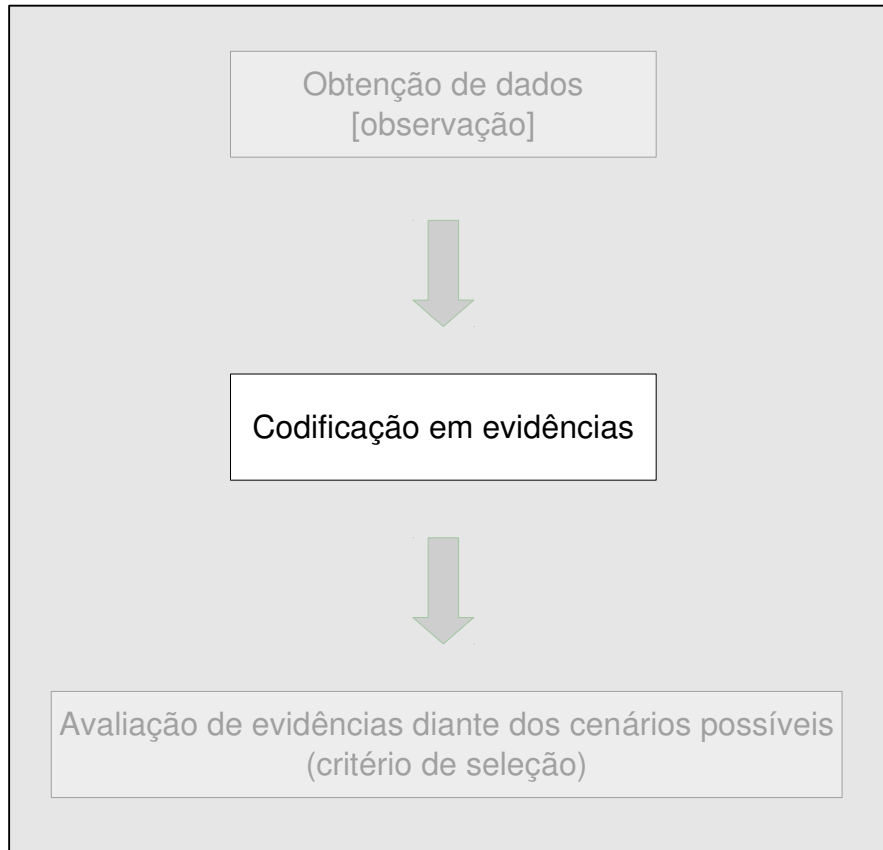

## Qual a diferença entre dados e evidências?

### **dados** \*

*sm pl 1* Conjunto de material (= informações) disponível para análise.

**Scientific evidence** \*\* has no universally accepted definition but generally refers to evidence which serves to either support or counter a scientific theory or hypothesis. Such evidence is generally expected to be empirical and properly documented in accordance with scientific method such as is applicable to the particular field of inquiry.

\* Fonte: Michaelis em [www.uol.com.br](http://www.uol.com.br).

\*\* Fonte: <http://en.wikipedia.org>

# Lógica da inferência filogenética

Codificação em Fenética deve refletir similaridade global

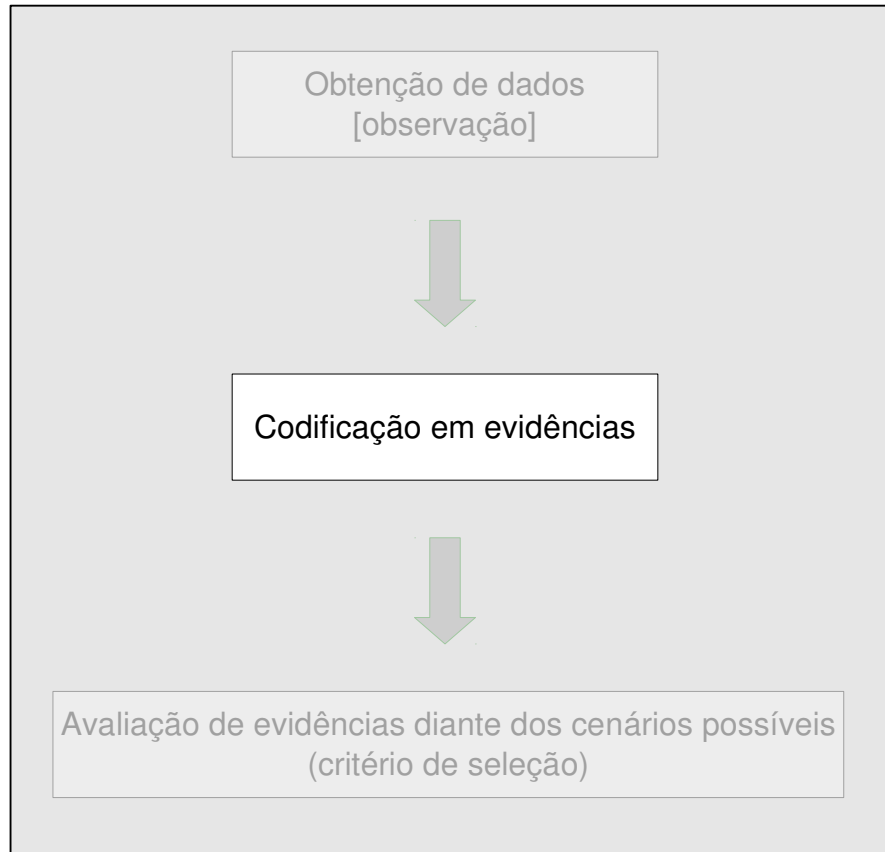

**Z** TAGAGCAATCCCTAACTG-AA  
**A** TAGAGCA-TCGCTA-CTA-AA  
**B** TAGAGCAATCACTAACTG-GA  
**C** TAGAGCTGTCTCTAACAGA--  
**D** TAGAGCTATCACAAACAGAAA

**Z** TAGAGCAATCCCTAACTG-AA  
 \* \* \* \*  
**A** TAGAGCA-TCGCTA-CTA-AA

	[Z]	[A]	[B]	[C]	[D]
Z	-				
A	0.10	-			
B	0.10	0.17	-		
C	0.23	0.27	0.22	-	
D	0.20	0.29	0.20	0.17	-

Codificação em matriz de distância

Comparação par a par

Codificação em matriz de distância

£ Não leva em consideração a presença de INDELS, isto é gaps (e.g., "-")

# Lógica da inferência filogenética

Avaliação e critério de seleção:

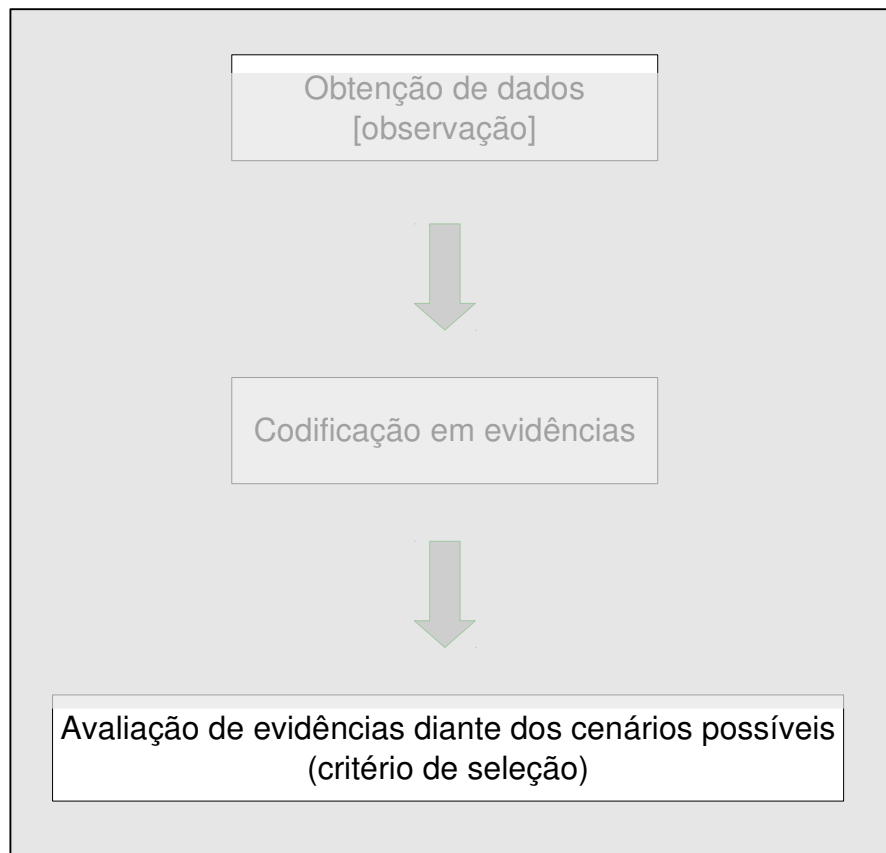

## Resoluções possíveis

Tree 0:

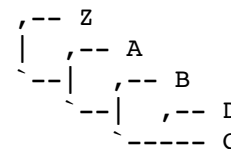

Tree 5:

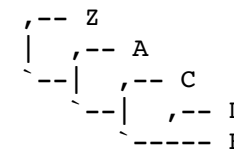

Tree 10:

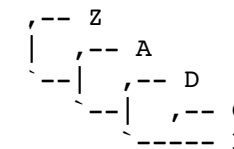

Tree 1:

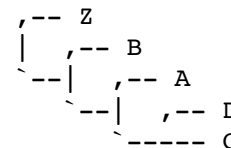

Tree 6:

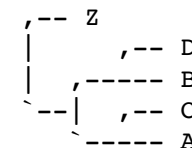

Tree 11:

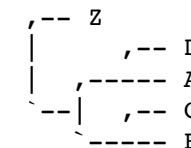

Tree 2:

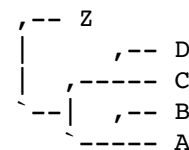

Tree 7:

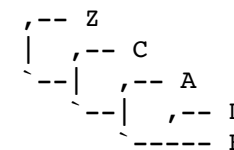

Tree 12:

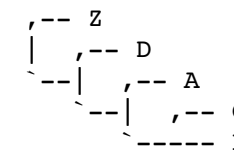

Tree 3:

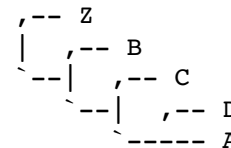

Tree 8:

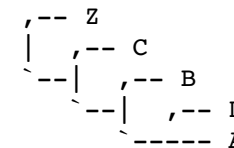

Tree 13:

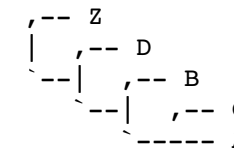

Tree 4:

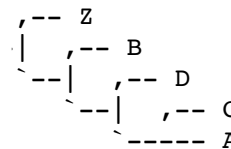

Tree 9:

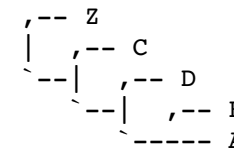

Tree 14:

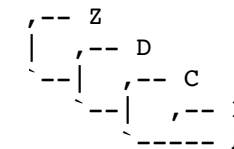

	[Z]	[A]	[B]	[C]	[D]
Z	-				
A	7	-			
B	7	6	-		
C	7	9	9	-	
D	5	7	7	4	-

# Lógica da inferência filogenética

## Representações gráficas para relações entre OUTs.

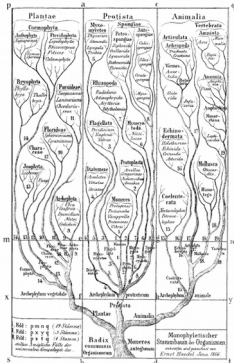
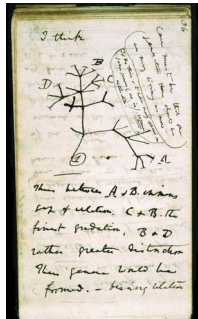

=

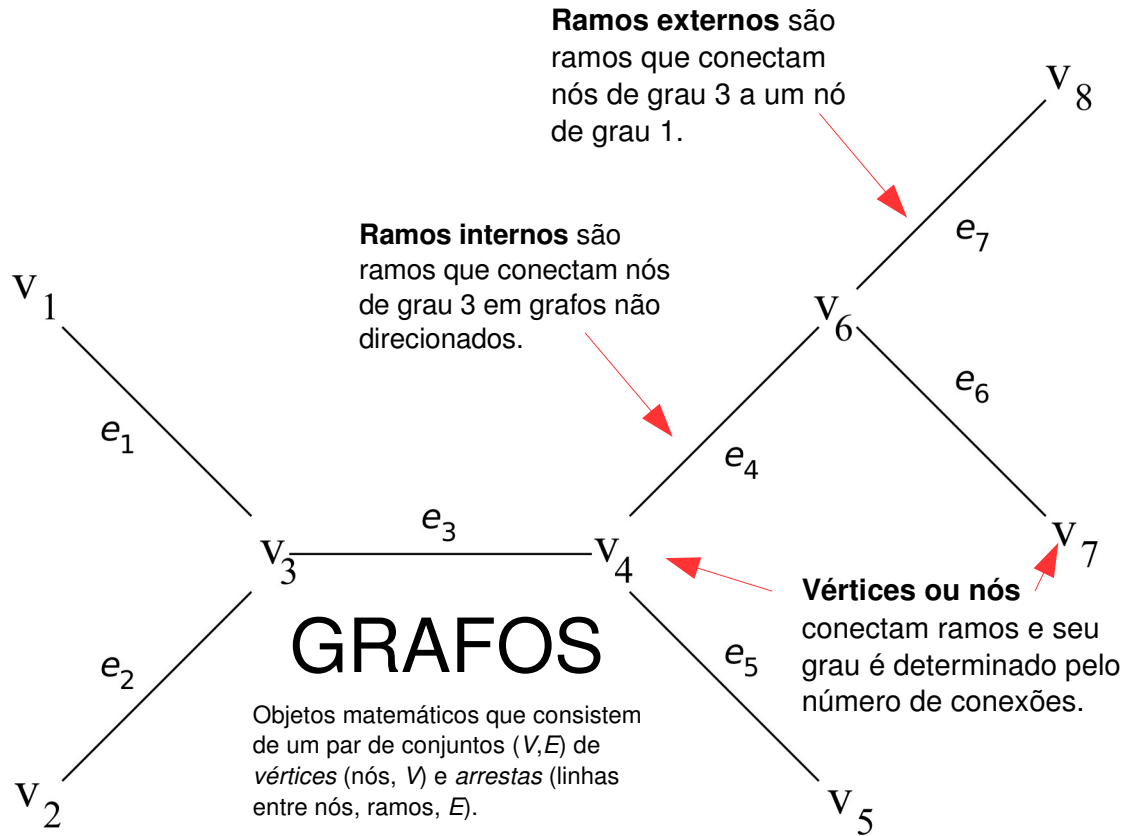

Um grafo é **binário** quando todos os nós internos possuem grau 3.

O **grau** de um nó é o número de ramos conectados a ele.

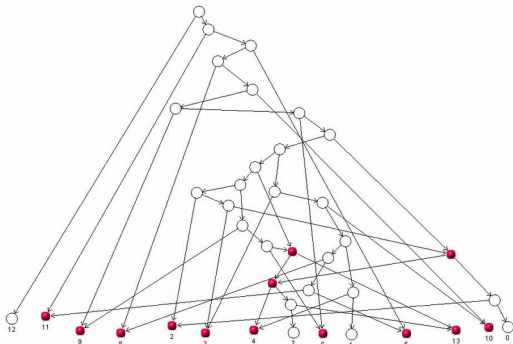



# Grafos: contexto filogenético

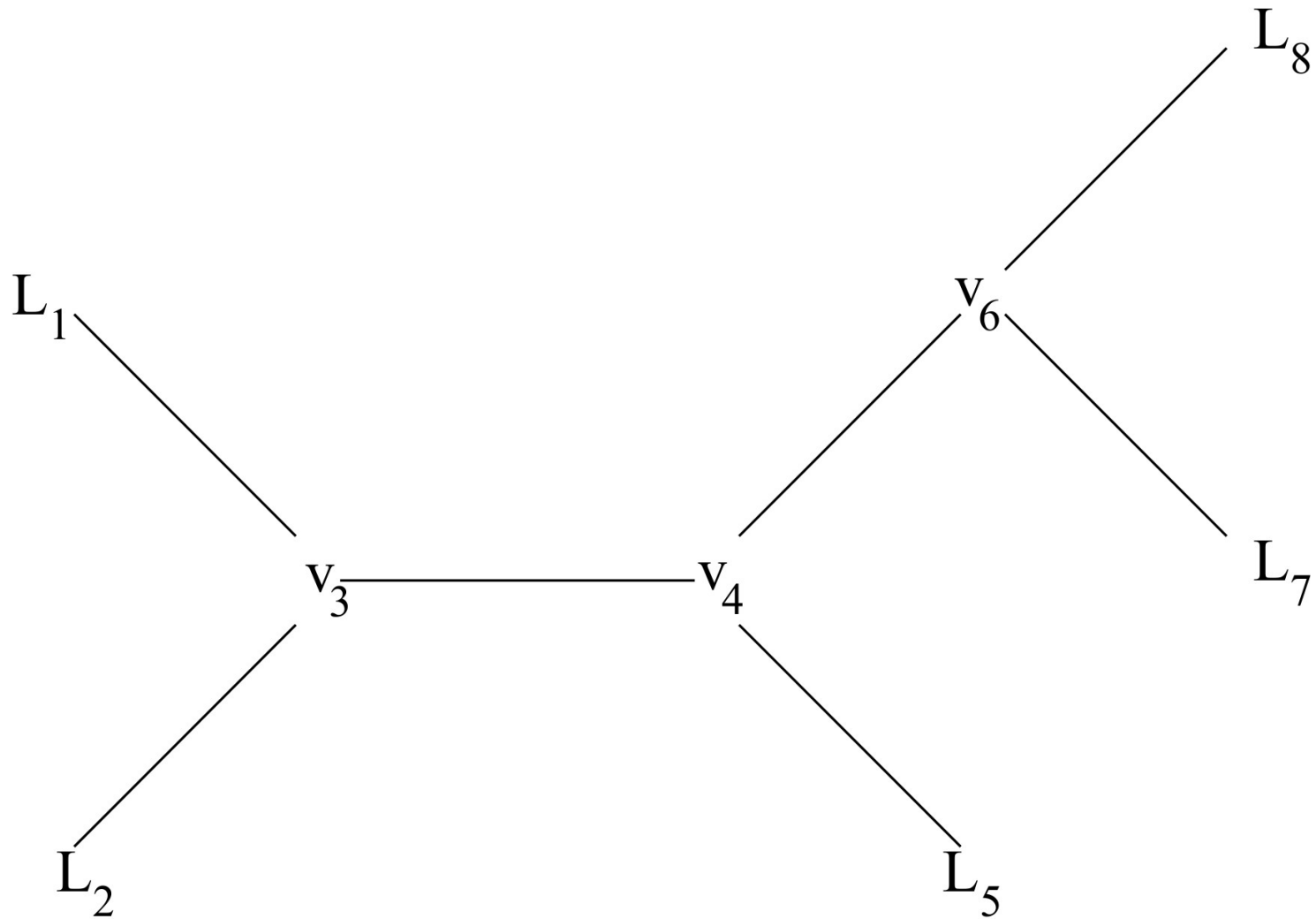

***L*** = Operational Taxonomic Units (**OTUs**)

***V*** = Hypothetic Taxonomic Units (**HTUs**)

# Grafos: contexto filogenético

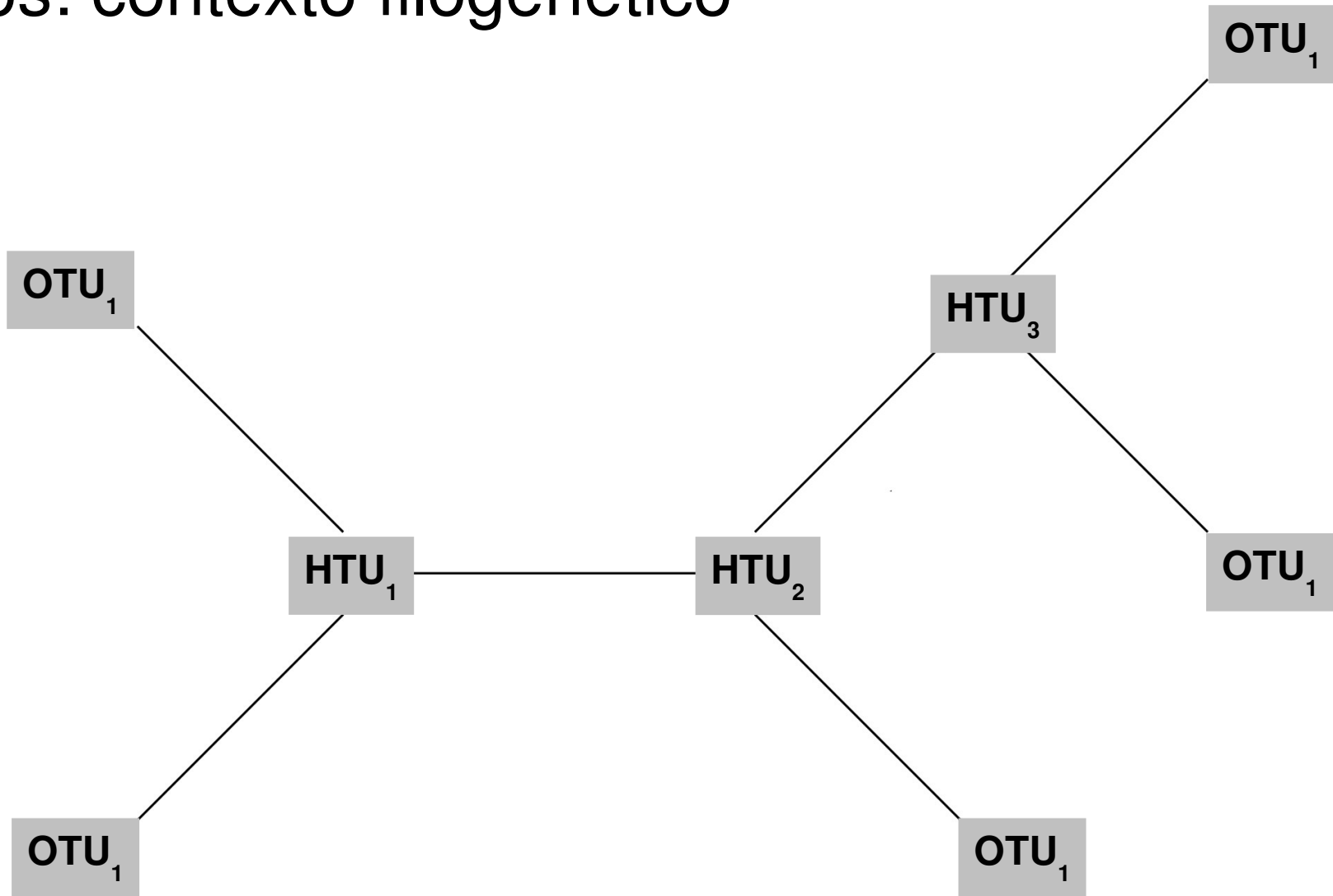

*L = Operational Taxonomic Units (OTUs)*

*V = Hypothetic Taxonomic Units (HTUs)*

# Grafos: sumário terminológico

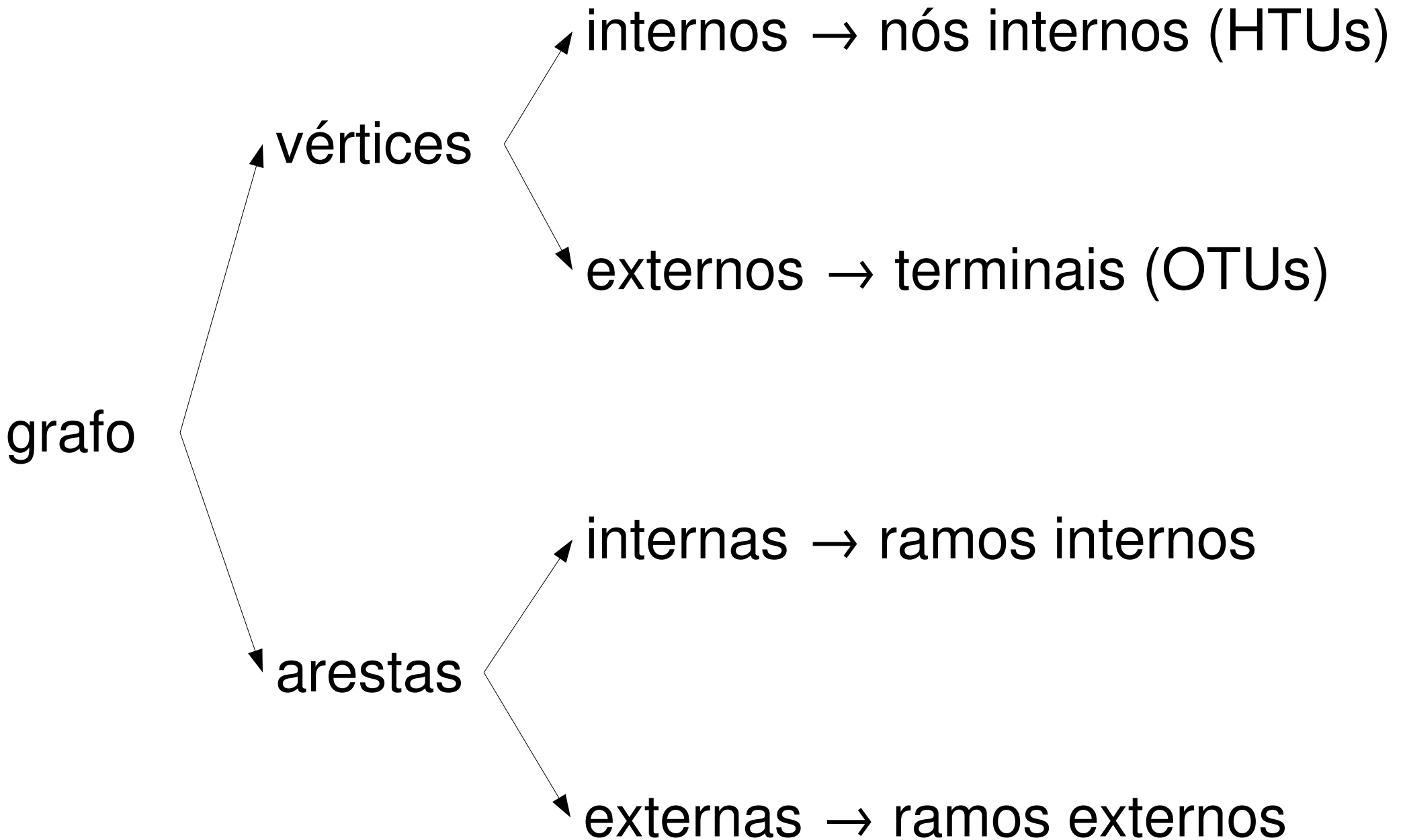

# Grafos: ciclos e direcionamento

*trees vs. networks*

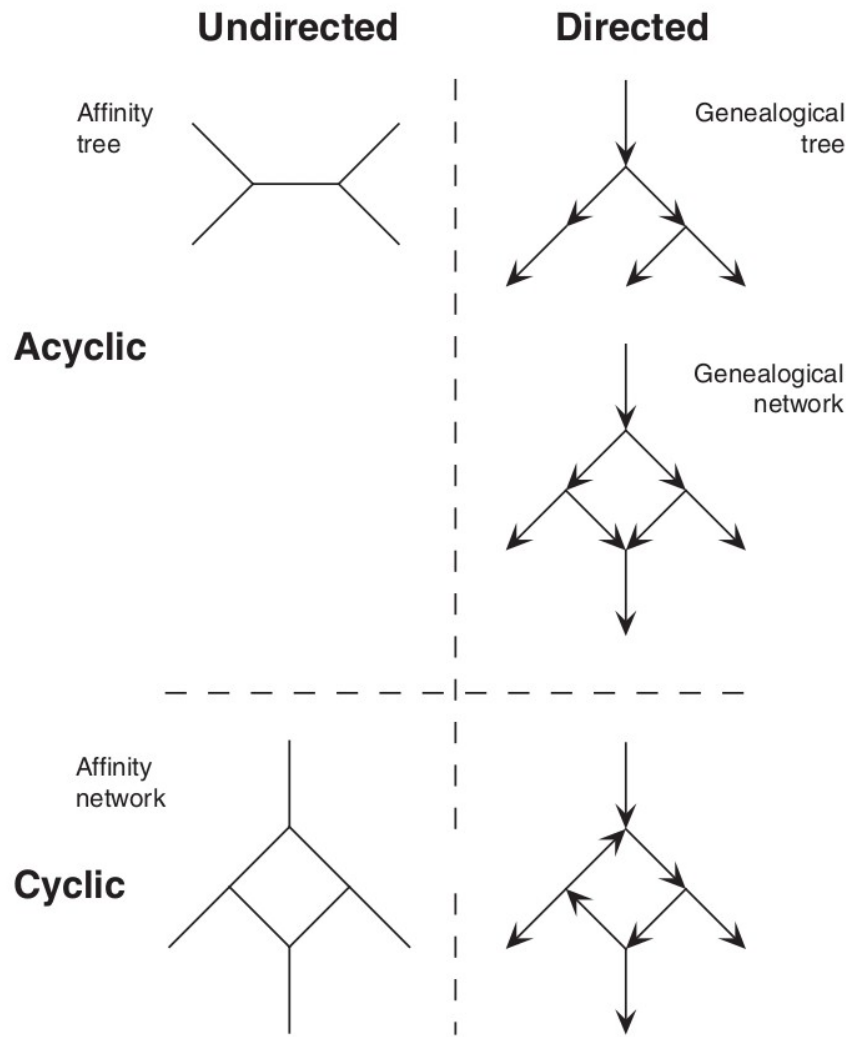

Não - direcionado

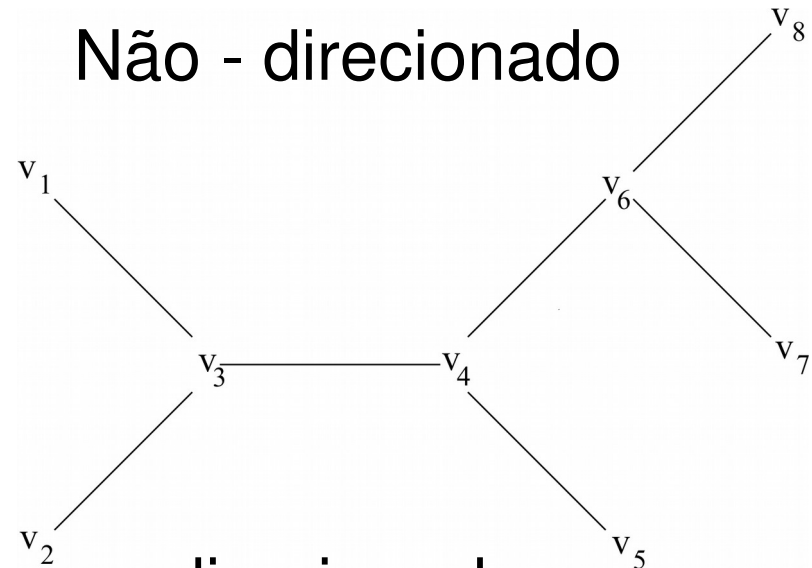

direcionado

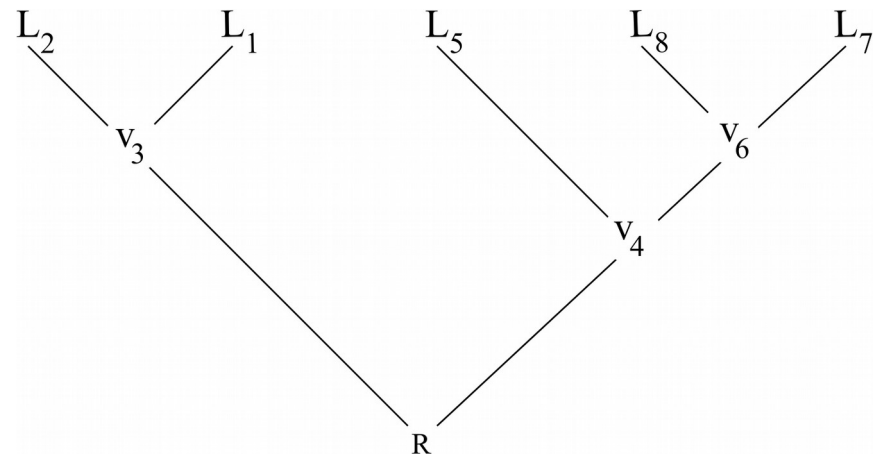

A raiz é o único nó com **grau 2**.

# Grafos: topologia

**Topologia:** refere-se às conexões entre vértices e arestas.

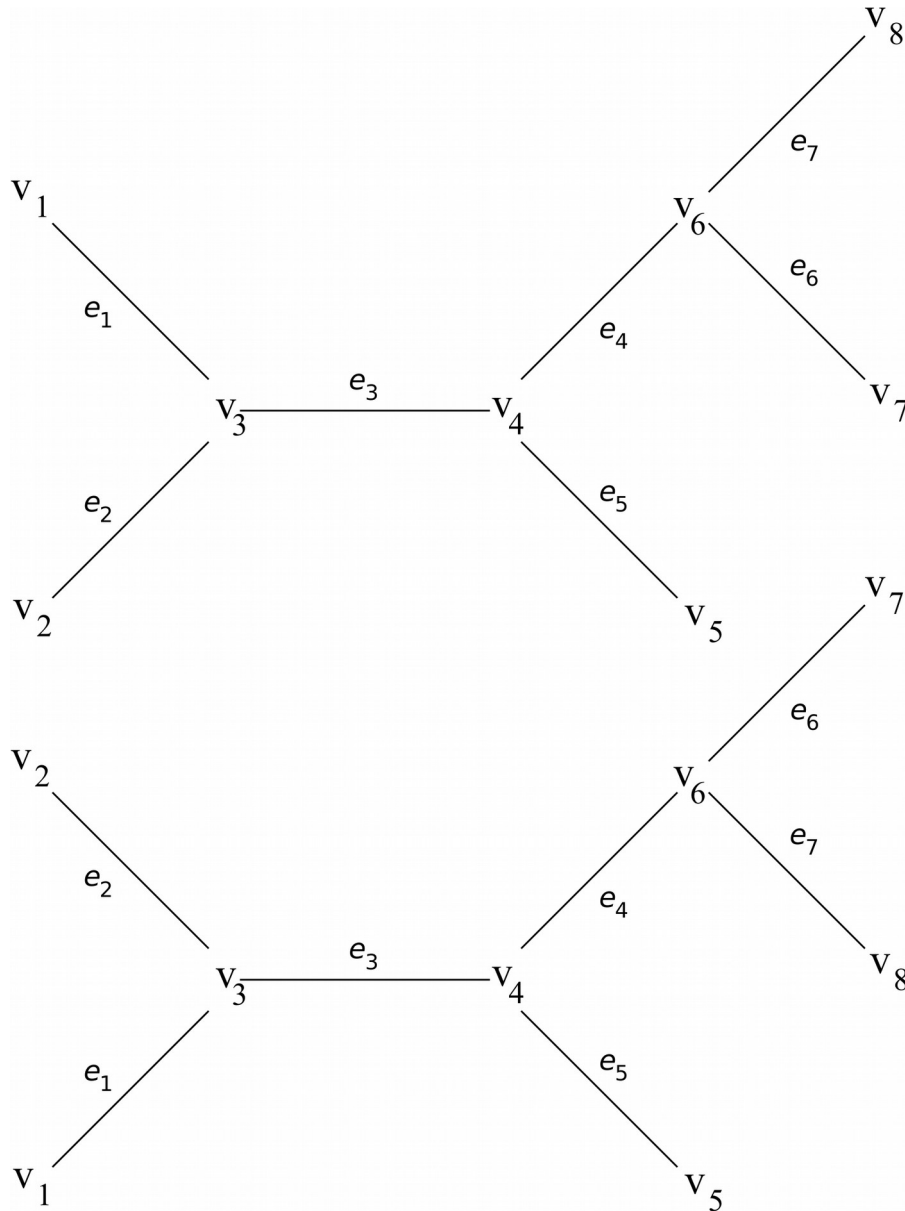

Ambos possuem  
a mesma  
topologia

# Grafos: resolução e teste de hipóteses

Hipóteses, “*Explanatory power*”, ambiguidade e testabilidade

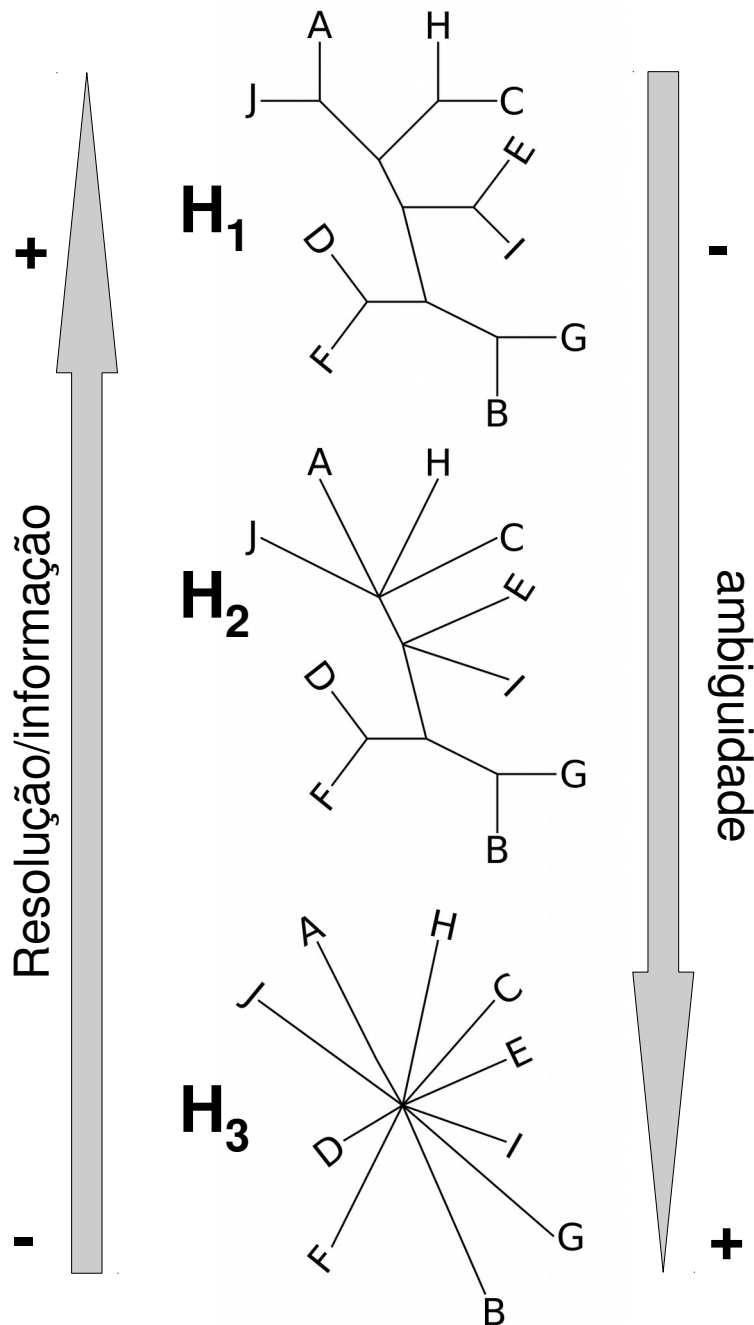

**Hipótese:** *uma explicação para um fenômeno observável ou uma proposição racional prevendo uma possível correlação causal entre múltiplos fenômenos.*

$H_1 \rightarrow H_3$ : decresce o conteúdo informativo (o que a hipótese explica)

Diagramas totalmente dicotômicos estão mais relacionados com o conteúdo informativo da hipótese do que com a suposição de que todo ancestral hipotético daria origem a somente duas linhagens por cladogênese.

# Lógica da inferência filogenética

Avaliação e critério de seleção:

Resoluções possíveis

	[Z]	[A]	[B]	[C]	[D]
Z	-				
A	7	-			
B	7	6	-		
C	7	9	9		
D	5	7	7	4	-

Tree 0:

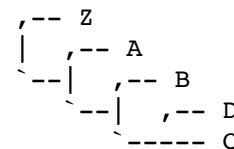

Tree 5:

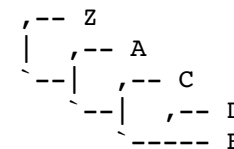

Tree 10:

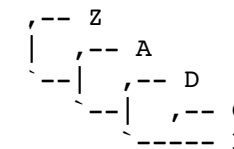

Tree 1:

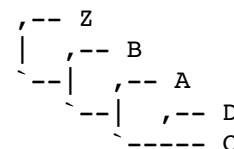

Tree 6:

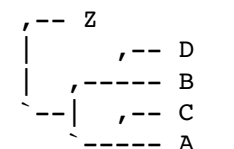

Tree 11:

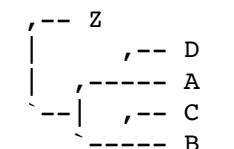

Tree 2:

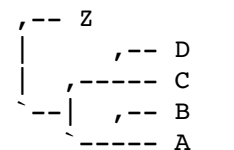

Tree 7:

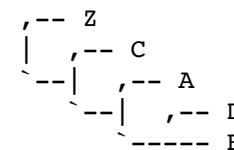

Tree 12:

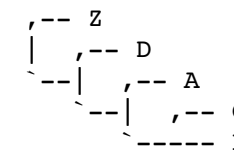

Tree 3:

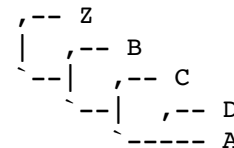

Tree 8:

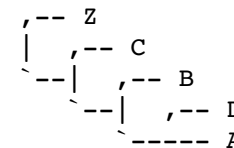

Tree 13:

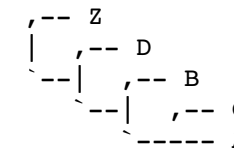

Tree 4:

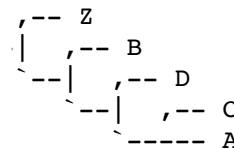

Tree 9:

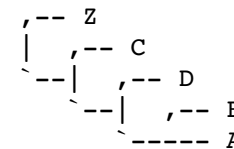

Tree 14:

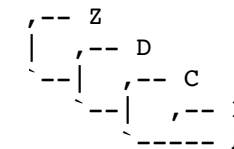

O que limita o espaço de soluções?

# Grafos: Enumeração de topologias

3 1  
 4 3  
 5 15  
 6 105  
 7 945  
 8 10395  
 9 135135  
 10 2027025  
 11 34459425  
 12 654729075  
 13 13749310575  
 14 316234143225  
 15 7905853580625  
 16 213458046676875  
 17 6190283353629375  
 18 191898783962510625  
 19 6332659870762850625  
 20 221643095476699771875  
 21 8200794532637891559375  
 22 319830986772877770815625  
 23 13113070457687988603440625  
 24 563862029680583509947446875  
 25 25373791335626257947657609375  
 26 1192568192774434123539907640625  
 27 58435841445947272053455474390625  
 28 2980227913743310874726229193921875  
 29 157952079428395476360490147277859375  
 30 8687364368561751199826958100282265625  
 31 495179769008019818390136611716089140625  
 32 29215606371473169285018060091249259296875  
 33 1782151988659863326386101665566204817109375  
 34 112275575285571389562324404930670903477890625  
 35 7297912393562140321551086320493608726062890625  
 36 488960130368663401543922783473071784646213671875  
 37 33738248995437774706530672059641953140588743359375  
 38 2395415678676082004163677716234578672981800778515625  
 39 174865344543353986303948473285124243127671456831640625  
 40 13114900840751548972796135496384318234575359262373046875

Para topologias não direcionadas e  $n \geq 3$ :

$$\frac{(2n - 4)!}{(n - 2)! 2^{n-2}}$$

O número de topologias enraizadas pode ser calculado multiplicando a fórmula acima pelo número de ramos  $(2n-3)$  ou incrementando  $+1$  à  $n$ .

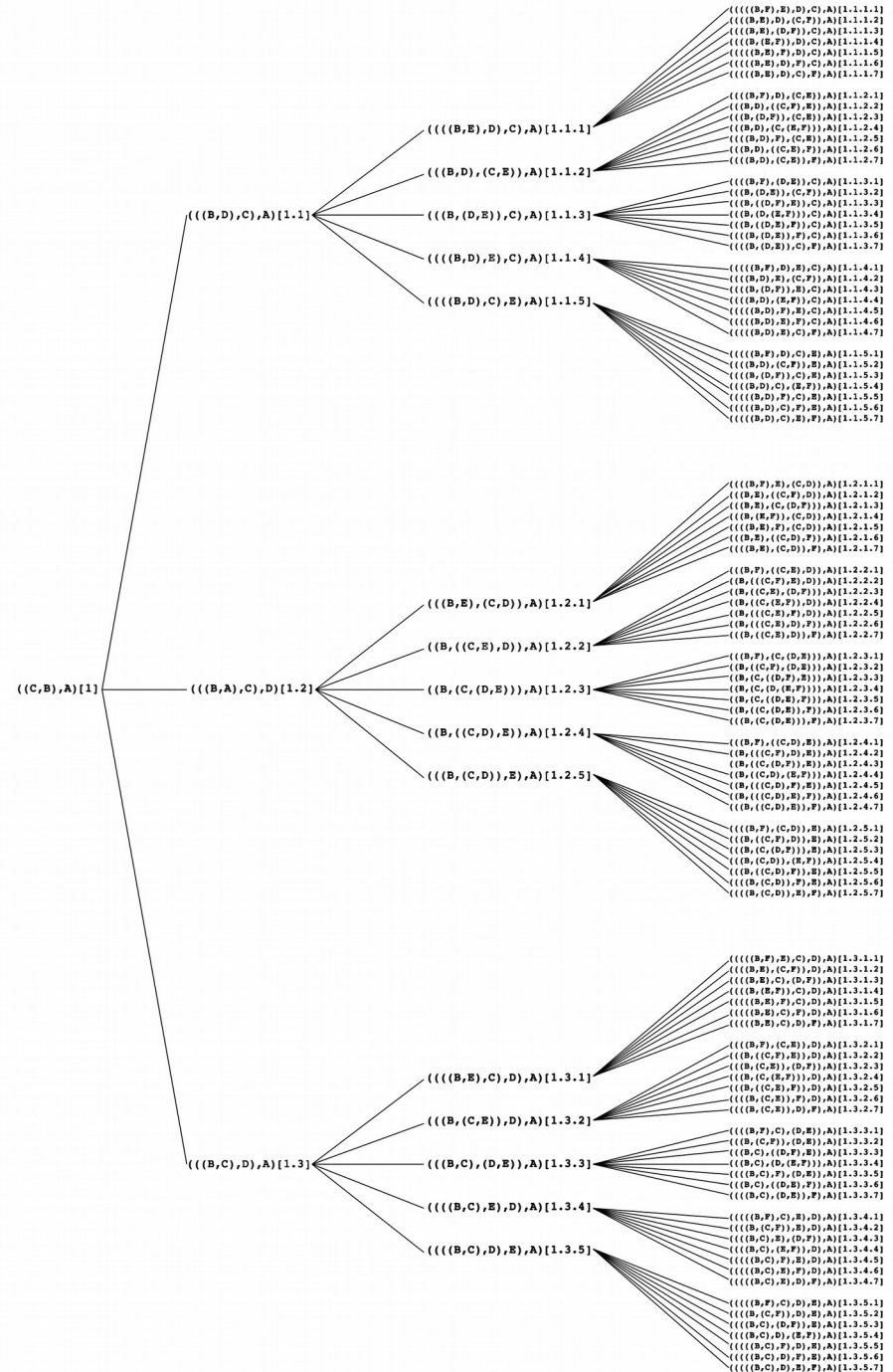



# Lógica da inferência filogenética

Avaliação e critério de seleção:

Resoluções possíveis

	[Z]	[A]	[B]	[C]	[D]
Z	-				
A	7	-			
B	7	6	-		
C	7	9	9	-	
D	5	7	7	4	-

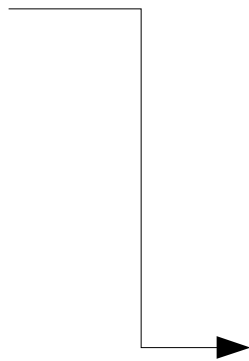

Tree 0:

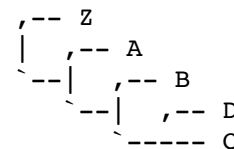

Tree 1:

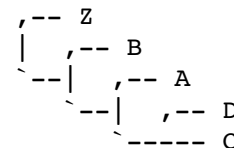

Tree 2:

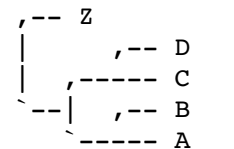

Tree 3:

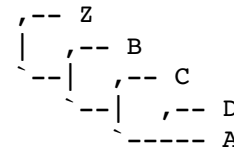

Tree 4:

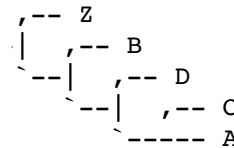

Tree 5:

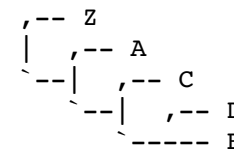

Tree 6:

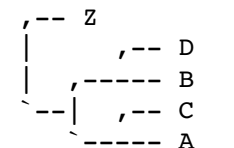

Tree 7:

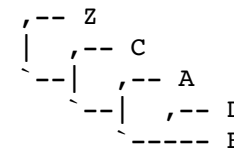

Tree 8:

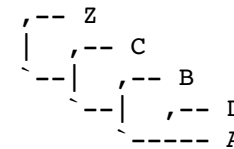

Tree 9:

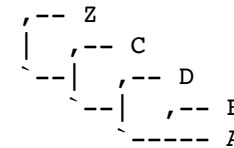

Tree 10:

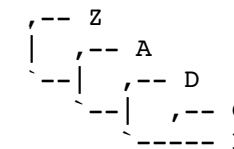

Tree 11:

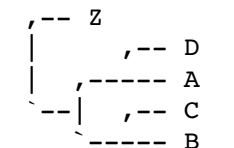

Tree 12:

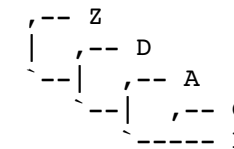

Tree 13:

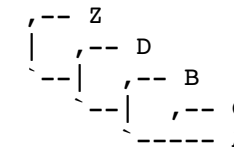

Tree 14:

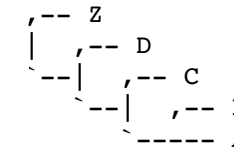

Qual topologia melhor explica meu conjunto de evidências?

# *Critério de otimalidade*: critério de seleção

Topologias como hipóteses:

Teste → Avaliação → Determinação de qualidade relativa

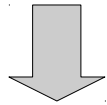

Índices de mérito comparativos

Independente do índice: requer função objetiva

$$C = f(D, T)$$

*'Without such a cost, these objects are mere pictures — “tree-shaped-objects” of no use in science'*  
(Wheeler et al., 2006: Cladistics 12:1-9)

# *Critério de otimalidade: Fenética*

Função objetiva:

$$C = f(D, T)$$

*Índice de similaridade global* =  $f$  (

sp_X	CTGGCTACGT
sp_A	TGGAGTAAGT
sp_B	CCTAGCAAGT
sp_C	CCTGATTGCA

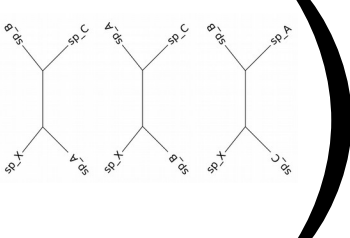
, 

# Lógica da inferência filogenética

## Fenética:

EVIDÊNCIAS: similaridade global  
MORFOLOGIA e/ou MOLECULAR

## Matriz de distância:

	[Z]	[A]	[B]	[C]	[D]
Z	-				
A	7	-			
B	7	6	-		
C	7	9	9	-	
D	5	7	7	4	-

## Fenograma\*:

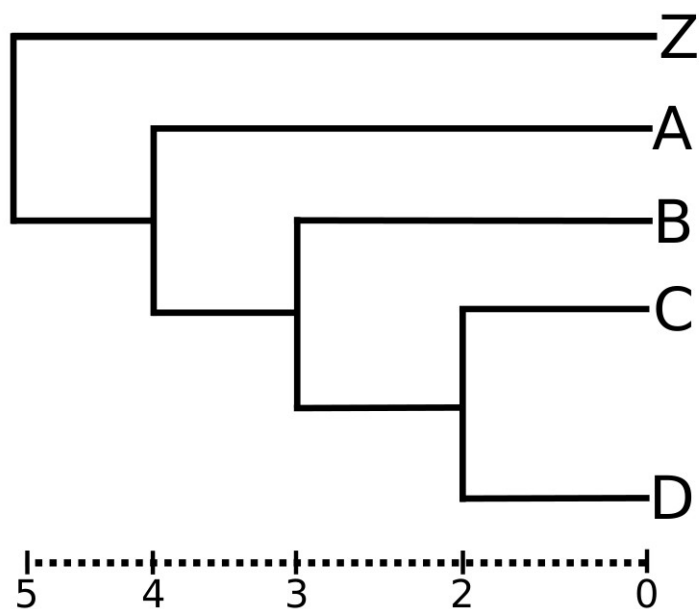

## Resoluções possíveis

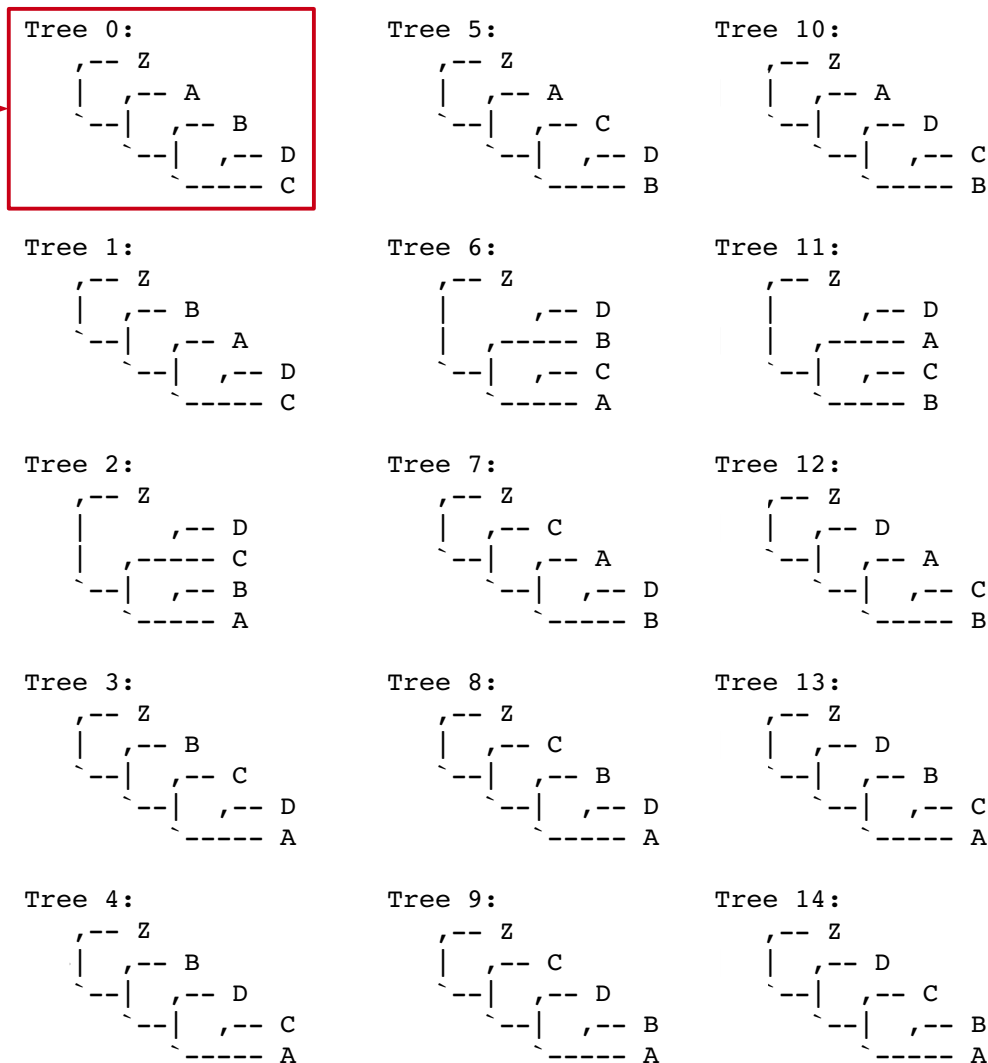

\* caráter ilustrativo pois não representa a matriz de distância acima.

# *Lógica da inferência filogenética: Fenética*

Problemas com o método:

1. Desconsidera que semelhanças decorrem de processos não relacionados com relação de parentesco.

2. Método é incapaz de manter as relações de distâncias originais para matrizes com mais de 4 terminais. Considere:

	[X]	[A]	[B]	[C]
X	-			
A	5	-		
B	6	4	-	
C	7	9	7	-

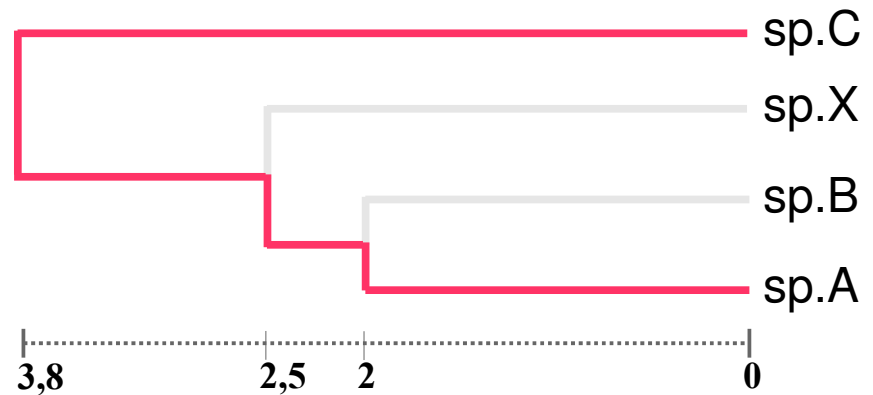

# Lógica da inferência filogenética: Fenética

## Problemas com o método:

### 3. Realismo:

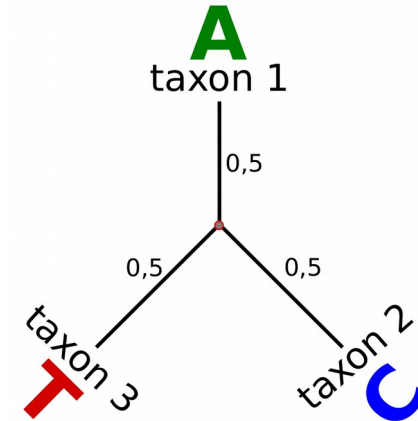
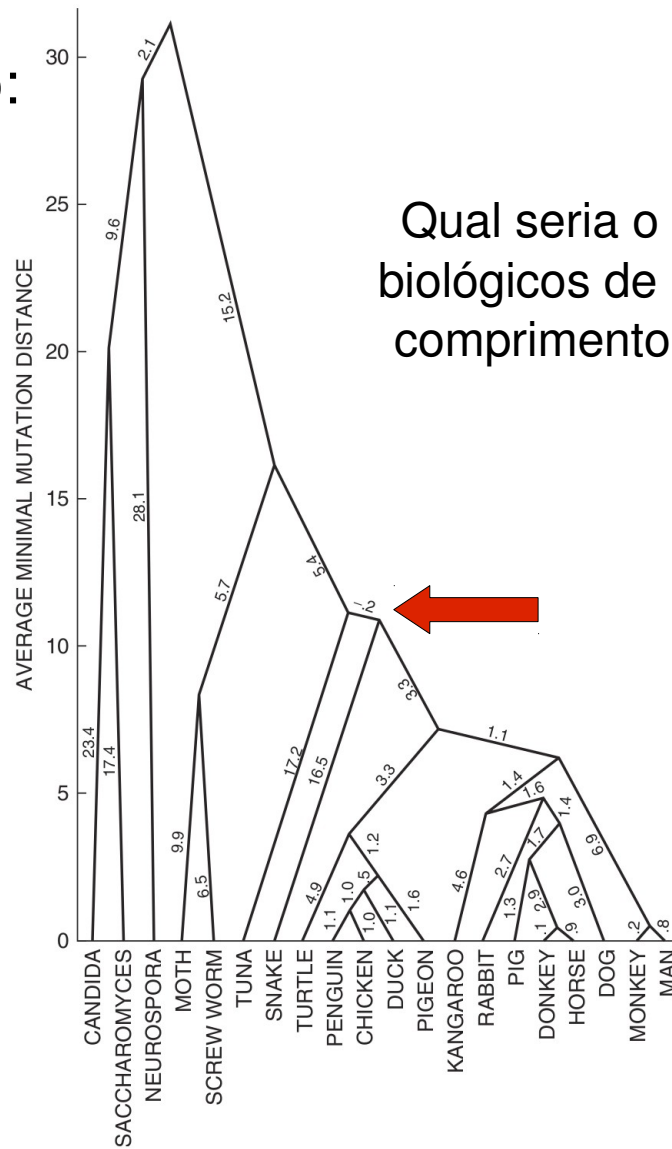

Qual seria o par de base presente no ancestral comum destes terminais?

Figure 9.13: Fitch–Margoliash analysis of cytochrome *c* protein sequences (Fitch and Margoliash, 1967). Note the negative branch length on the edge leading to tetrapods.

# Lógica da inferência filogenética: Fenética

Problemas com o método:

## 4. Perda de informação:

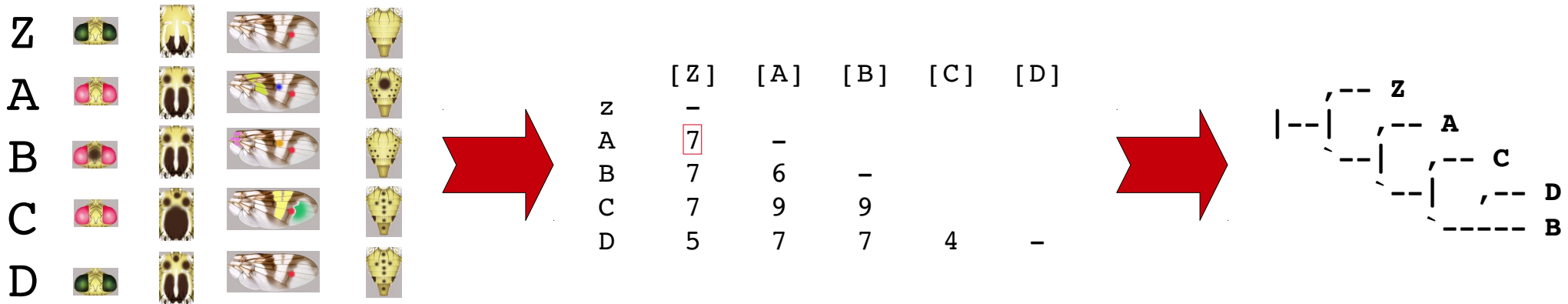

# ***Conceitos fundamentais desta aula:***

Homologia vs. homoplasia

Fenética ou Taxonomia Numérica

Fenogramas

Inferência Filogenética:

- Obtenção de dados

- Codificação e evidências

- Avaliação e seleção de hipóteses

  - Grafos

  - OTUs e HTUs

  - Enumeração

  - Critério de otimização

Problemas metodológicos da Fenética